

MATRIX

VERTICAL  
CHEST PRESS

2025 BROCHURE

**STRENGTH**



# CONTENTS

## **4 BELIEVE IN BETTER**

*TOTAL SOLUTIONS PARTNER*

## **8 MATRIX STRENGTH OVERVIEW**

*STRENGTH THAT NEVER RESTS*

## **12 ULTRA SERIES**

*THE ULTIMATE STRENGTH TRAINING EXPERIENCE*

## **16 CONNECTED SOLUTIONS**

*GET CONNECTED TO A WORLD OF DIGITAL SOLUTIONS*

## **30 VERSA SERIES**

*THE POWER OF CHOICE IN STRENGTH TRAINING*

## **52 AURA SERIES**

*THE STANDARD IN PERFORMANCE AND DESIGN*

## **78 GO SERIES**

*DISCOVER THE STRENGTH OF SIMPLICITY*

## **90 MAGNUM SERIES**

*A LEGACY OF PERFORMANCE AND PROVEN DURABILITY*

## **128 VARSITY SERIES**

*DESIGNED FOR SUPERIOR VALUE AND TRAINING VARIETY*

## **136 G1 SERIES**

*DIVERSITY AND DURABILITY TO GET THE JOB DONE*

## **148 WEIGHT STACK KITS**

*SELECTORIZED VIBRATION REDUCTION SYSTEM*





# IN BETTER

At Matrix, it's our mission to make your fitness facility everything you ever dreamed it could be.

Count on us for meaningful innovations that make our equipment a joy to own, service and use. Expect a technology ecosystem that enhances the way you manage your facility, retain and engage members and promote your brand. And as always, trust us to put your brand and your business first, supporting you with facility planning, dedicated sales and support, unmatched customer service and extensive education and training.

**For all those who believe in better, there's Matrix.**



# BEFORE

## IN PARTNERSHIP THAT EMPOWERS

When you choose Matrix, you're getting a partner who will be there, for your grand opening and every day after.

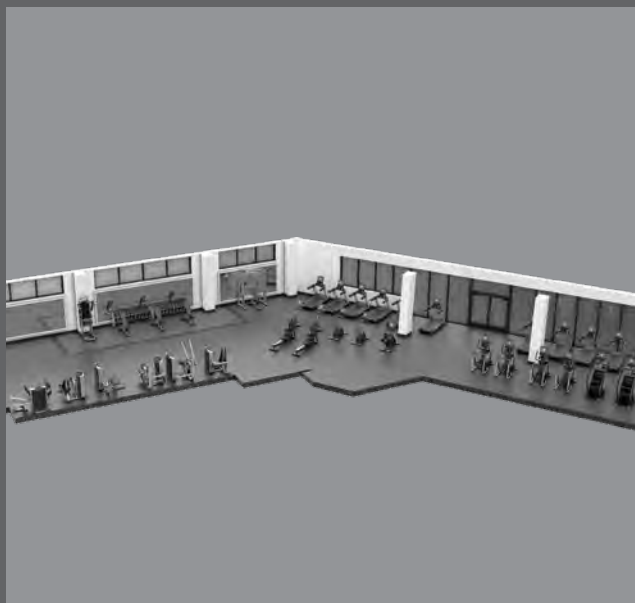

## DESIGNING YOUR VISION

Our team will work with you to bring your vision of fitness to life in exciting new ways by helping you select equipment and technology ideal for your goals, your space and the people you serve. We'll even work with you to develop financial solutions that expand your options and maximize your investments.



## CREATING YOUR VISION

We'll get you up and running on your schedule and provide your staff with all the tools they need to stay that way. Additionally, your team can count on a complete demonstration of how to use your new equipment to its fullest potential.



## SUPPORTING YOUR VISION

You can rely on our swift service response, readily available parts and unwavering commitment to resolving issues the first time. You can also access product training, maintenance tips, on-demand educational videos and much more at [matrixlearningcenter.com](https://matrixlearningcenter.com). And count on our marketing support kits to engage your people, spotlight your brand and showcase what makes your facility special.

# STRENGTH

## overview

Matrix doesn't just manufacture strength equipment — we craft training tools that evolve with your fitness facility and your lifters. We listen to owners, trainers and users to put real-world insights at the heart of our designs, captivating a new generation and delivering innovation that outperforms the ordinary in better, smarter ways. Best of all, we built on the decades of strength manufacturing experience through the acquisition of Magnum Fitness Systems, and continue to design and develop all of our durable training tools in the USA, the global epicenter of strength training.

Choose Matrix, and discover strength that never rests.





## ULTRA<sub>series</sub>

### THE ULTIMATE EXPERIENCE

Powerful yet comfortable. Advanced functionality with intuitive operation. The industry's most durable components wrapped in breathtaking industrial design. The Ultra Series goes beyond your expectations of strength training equipment to earn and retain members like nothing else.



## VERSA<sub>series</sub>

### THE POWER OF CHOICE

Bring your vision of fitness to life — our most versatile series gives you the options to build a strength training area that fits your space and the needs of your members in a beautifully precise way. The Versa Series incorporates advanced biomechanics for a natural, smooth, efficient workout experience.



## AURA<sub>series</sub>

### PREMIUM PERFORMANCE & DESIGN

Superior styling made the Aura Series an instant classic. Signature features made it one of the most-imitated product lines in the industry. Choose the Aura Series, and you'll discover that beginners and fitness enthusiasts alike will be drawn to something that the competition can't imitate — an unmistakable aura of greatness.



## GO SERIES series

### THE STRENGTH OF SIMPLICITY

Now you can engage users new to strength training and circuit programs with our easy-to-use, space-efficient Go Series. Minimal adjustments, low starting weights and smaller progressions create a welcoming experience where anyone can sit and go, while compact footprints, back-to-back designs and low stack heights fit your space and budget.



## MAGNUM series

### PROVEN PERFORMANCE & DURABILITY

Born from a long tradition of premium performance, there's no better choice for professional athletes than the unrivaled performance and durability of the Magnum Series. Advanced options like Breaker Benches and MEGA Racks help athletes reach their potential, and the impeccable designs stand up to the most demanding environments.



## VARSITY series

### PERFORMANCE, VALUE & VARIETY

For a blend of performance and value perfect for heavy-use facilities, look no further than the Varsity Series. It offers the dynamic performance and superior ergonomics that the fitness world has come to expect from Matrix, plus the uncompromising durability you need to accommodate a steady stream of users.



## G1 series

### DIVERSITY & DURABILITY

The G1 Series provides an ideal blend of value and variety for cost-conscious facilities. It offers a range of durable options with a classic look. From space-saving multi-station units to ever-popular benches, this series will meet your members' needs for years to come.

# MORE THAN ONE WAY TO BUILD STRENGTH

We offer a complete collection of strength equipment to meet the needs of not just your people, but your space, too.

## **SINGLE-STATION**

Operation is intuitive, and our high-performance designs ensure that your members are getting the most out of every moment they spend pursuing their fitness goals.

ULTRA / VERSA / AURA / VARSITY / GO

## **PLATE-LOADED**

Thoughtful design and attention to detail make our stations easier to load, unload and access, so members can get the workout they need, where they need it, and keep going.

MAGNUM / VARSITY

## **MULTI-STATION**

Multi-station units make the most of your floor space and help members make the most of their workout time. Smart designs let users take on multiple exercises in a small space, with quick weight adjustments to maximize results.

VERSA / AURA / GO / G1

## **RACKS & PLATFORMS**

When serious strength training enthusiasts see our premium racks on your floor, they'll know they're in the right place and keep coming back for more.

MAGNUM

## **FREE WEIGHTS**

Choose from our unique series to find the combination of iron and ergonomics right for your facility, and count on exclusive features and industrial design to attract aspiring fitness enthusiasts and seasoned lifters alike.

MAGNUM / GO / G1

# THE ULTIMATE STRENGTH TRAINING EXPERIENCE

ULTRA  
series

The powerful and comfortable Ultra Series gives you the most advanced functionality with an intuitive design that couldn't be easier to operate. Both durable and beautiful, the Ultra Series will exceed your expectations when it comes to earning and retaining members.





# ULTRA

## series

### **ACTION SPECIFIC GRIPS**

Ergonomically designed to reduce stress on contact points while enhancing feel, function and form.

### **LOW STACK HEIGHT**

A uniformly low stack height (135 cm / 53") improves the aesthetic and flow of your fitness center.

### **INDEPENDENT CONVERGING/DIVERGING MOTION**

Encourages a natural path of motion to enhance comfort.

### **INCREMENTAL WEIGHTS**

Easy to access and reference from the seated position.

### **USER AMENITIES**

All single-station units offer a convenient accessory pad, personal device holder and towel hook.

### **ELECTRONIC REP COUNTER**

Tracks reps, activity time and rest time for enhanced user data tracking and a streamlined workout experience.

### **EXERCISE PLACARDS**

Easy-to-read reference cards highlight targeted muscle groups and proper machine use.

### **ULTRA OPTIONS**

- Choose between Standard and Heavy Weight Stacks.
- Add Intelligent Training Console for a guided, fully connected strength training experience.



# ULTRA INTELLIGENT TRAINING CONSOLE

When you choose Ultra Series with Intelligent Training Console, you'll get a digitally connected, guided experience. The intuitive touchscreen makes it easy for members of all levels to define physical transformation targets, identify their benchmark weight and receive step-by-step instructions. Then members can take on personalized progression programs that will help them reach their goals in smart new ways.

With convenience features like touch-free RFID login and stored seat settings, they'll be able to easily start a workout, transition between equipment and review previous workouts to chart their development—maximizing their time and results. Our WiFi-enabled console also works seamlessly with our digital portfolio of Connected Solutions, including Engage 360, Community 360 and Asset Management.





## A GUIDED TRAINING EXPERIENCE

Ideal for those new to strength training or experienced members who are struggling to progress. Intelligent Training Console features Endurance, Build and Strength programs to give members a guided training experience specific to their goals.

## ORIGINAL PROGRESSIONS

Original progression-based programming designed in collaboration with the National Strength and Conditioning Association (NSCA) helps members find a benchmark weight and provides 8–12 weeks of workouts to maximize results.

## EXPLOSIVE LIFTING

The explosive lifting program focuses on speed and power instead of just strength, helping members accelerate results while keeping the strength training experience fresh.

## WORKOUT HISTORY

Workout history snapshot lets members quickly review past sessions and track overall progress.

## DEMO VIDEOS

On-console demo videos provide guidance on maintaining proper form for each exercise.

## INTUITIVE NAVIGATION

Intuitive touchscreen console navigation makes it easy for members of any ability or experience level to get started.

## DUAL USER SIGN-IN

Dual user sign-in streamlines transitions between two alternating users and their specific strength training programs.

## RECORDED SETTINGS

Stored seat settings make it easy for users to find the same ergonomically sound fit every time they work out.

## TOUCH-FREE LOGIN

Included RFID capability gives users a quick, touch-free way to login, load their personal preferences and start their workout.

## FULLY CONNECTED TECHNOLOGY

Internet connectivity via WiFi or ethernet provides access to included Asset Management and optional add-ons, such as Community 360 and Engage 360.

## BRAND-BUILDING CUSTOMIZATION

Customizable interface strongly represents your brand to provide a unified look and feel throughout your entire facility.

## INTELLIGENT TRAINING CONSOLE SPECIFICATIONS

### CONSOLE

Display Type	40.6 cm / 16" capacitive touchscreen LCD
Display Feedback	Reps, sets, rest time, heart rate, total weight, lift time
Workouts	Manual, endurance, build, custom, strength*, explosive lifts*
User-defined Multi-language Display	English, German, French, Italian, Spanish, Dutch, Portuguese, Chinese-S, Chinese-T, Japanese, Korean, Swedish, Finnish, Russian, Arabic, Turkish, Polish, Welsh, Basque, Vietnamese, Somali, Danish, Malaysian, Catalan, Thai, Greek
Lift to Start	Yes
Ethernet	Yes
WiFi	Yes
Bluetooth	Yes; heart rate
USB Port	Software updates only
RFID Wireless Login	Yes
Dual User Sign-in	Yes
CSAFE Ready	Yes
Community 360 Compatible	Yes
Facility Communication Portal / Calendar	No
Engage 360 Compatible	Yes
EGYM Compatible	Yes
Asset Management Compatible	Yes
Stored User Settings	Yes- Seat settings and Bluetooth HR
Strength Series Compatibility	Ultra Series June 2022 or newer

### TECH SPECS

Power Requirements	100-240V / 50-60Hz AC
Assembled Dimensions	147.3 cm / 58" (As assembled on the Ultra weight stack)
Shipping Dimensions	51 x 42 x 25 cm / 20.1" x 16.5" x 9.8"
Shipping Weight	9.4 kg / 21 lbs.

\*Ultra Base models exclude Action Specific Grips, electronic rep counters, aluminum tops, incremental weights and aluminum seat links.



### CONVERGING CHEST PRESS

Independent converging movement provides a natural path of motion • Adjustable back pad with gas assist facilitates easy range of motion changes • Integrated foot platform provides additional user stability and comfort during use • Designed for easy entry and exit • Ultra Base G7-S21B and Ultra Base Heavy Stack G7-S21BH

	PRODUCT DIMENSIONS (L X W X H)					PRODUCT WEIGHT		WEIGHT STACK		
	CM		INCHES			KG	LBS	KG	LBS	
<b>G7-S13</b>	168.5	141	135	66.3	55.4	53	343.9	758.9	108	240



### LATERAL RAISE

Oversized arm pads enhance comfort and accommodate a variety of users • Rotating handles provide natural motion • Available as Ultra Base G7-S21B and Ultra Base Heavy Stack G7-S21BH

	PRODUCT DIMENSIONS (L X W X H)					PRODUCT WEIGHT		WEIGHT STACK		
	CM		INCHES			KG	LBS	KG	LBS	
<b>G7-S21</b>	105.5	150	135	41.5	59	53	276.8	610.5	90	200



### PEC FLY / REAR DELT

Rotating grips provide comfort and smooth movement during use • Angled back pad and delt grips enhance user comfort and improve biomechanics • Oversized handles reduce the need to adjust the seat position between rear deltoid and fly exercises • Heavy weight stack accommodates advanced users • Available as Ultra Base G7-S22B and Ultra Base Heavy Stack G7-S22BH

	PRODUCT DIMENSIONS (L X W X H)						PRODUCT WEIGHT		WEIGHT STACK	
	CM		INCHES				KG	LBS	KG	LBS
<b>G7-S22</b>	143.5	193.5	197	56.4	76.1	77.6	322.2	710.5	135	300



### CONVERGING SHOULDER PRESS

Independent converging movement provides a natural path of motion • Dual-position hand grips allow for greater training variety • Counterbalanced pressing arms provide reduced starting resistance • Reclining seat position allows for better posture and back support • Available as Ultra Base G7-S23B and Ultra Base Heavy Stack G7-S23BH

	PRODUCT DIMENSIONS (L X W X H)						PRODUCT WEIGHT		WEIGHT STACK	
	CM		INCHES				KG	LBS	KG	LBS
<b>G7-S23</b>	168	146.5	174	66.1	57.6	68.4	275.5	607.5	90	200



### DIVERGING LAT PULLDOWN

Independent diverging movement provides a natural path of motion • Angled seat encourages proper user position • High pads and seat easily adjust to provide stability, comfort and improved ergonomics • Available as Ultra Base G7-S33B and Ultra Base Heavy Stack G7-S33BH

	PRODUCT DIMENSIONS (L X W X H)						PRODUCT WEIGHT		WEIGHT STACK	
	CM			INCHES			KG	LBS	KG	LBS
<b>G7-S33</b>	152	161	195	59.6	63.1	76.7	380	838	108	240



### DIVERGING SEATED ROW

Independent diverging movement provides a natural path of motion • Dual-position foot placement provide greater user comfort • Adjustable chest pad with gas shock accommodates a variety of users • Available as Ultra Base G7-S34B and Ultra Base Heavy Stack G7-S34BH

	PRODUCT DIMENSIONS (L X W X H)						PRODUCT WEIGHT		WEIGHT STACK	
	CM			INCHES			KG	LBS	KG	LBS
<b>G7-S34</b>	158	138.5	140.5	62.2	54.5	55.3	344	758.5	108	240



### INDEPENDENT BICEPS CURL

Unique pivoting elbow pads and rotating handles improve function, comfort and feel during use • Designed for easy entry and exit without chest compression from traditional machines • Elbow pad wear covers improve upholstery performance in high contact areas • Available as Ultra Base G7-S40B and Ultra Base Heavy Stack G7-S40BH

	PRODUCT DIMENSIONS (L X W X H)						PRODUCT WEIGHT		WEIGHT STACK	
	CM		INCHES				KG	LBS	KG	LBS
<b>G7-S40</b>	135	168	135	53	66.2	53	263.6	581.5	90	200



### DEPENDENT ARM CURL

Rotating Action Specific Grips provide greater comfort and minimal point pressure • Arm pad is angled for stability and limits unwanted shoulder movement during exercise • Elbow pad wear cover improves upholstery performance and durability in high contact areas • Color-coded pivot indicates correct elbow placement for optimal feel and performance • Available as Ultra Base G7-S41B and Ultra Base Heavy Stack G7-S41BH

	PRODUCT DIMENSIONS (L X W X H)						PRODUCT WEIGHT		WEIGHT STACK	
	CM		INCHES				KG	LBS	KG	LBS
<b>G7-S41</b>	149	106.5	135	59	42	53	225.7	498	90	200



### TRICEPS PRESS

Oversized rotating handles adapt to a wide variety of users and provide exercise variation • Angled back pad reduces stress, improves stabilization and enhances comfort • Available as Ultra Base G7-S42B and Ultra Base Heavy Stack G7-S42BH

	PRODUCT DIMENSIONS (L X W X H)					PRODUCT WEIGHT		WEIGHT STACK		
	CM		INCHES			KG	LBS	KG	LBS	
<b>G7-S42</b>	124	121	135	48.8	47.7	53	298.5	658	120	265



### TRICEPS EXTENSION

Handles pivot to automatically adjust for varying forearm lengths • Padded hand rests provide a comfortable and stable pressing surface while reducing point pressure on the hands • Action Specific Grips provide greater comfort and tailored hand position for the movement • Color-coded pivot indicates correct elbow placement for optimal feel and performance • Foot pegs provide additional stability and support during heavy lifts • Available as Ultra Base G7-S45B and Ultra Base Heavy Stack G7-S45BH

	PRODUCT DIMENSIONS (L X W X H)					PRODUCT WEIGHT		WEIGHT STACK		
	CM		INCHES			KG	LBS	KG	LBS	
<b>G7-S45</b>	144.5	106.5	135	57	42	53	239.2	527.5	81	180



### ABDOMINAL CRUNCH

Sculpted back pads allow for full muscular contraction • Dual-supported pivoting design fosters a natural abdominal crunch motion • Self-aligning handles adjust to accommodate a variety of users, and elbow pad covers protect the upholstery at touchpoints • Available as Ultra Base G7-S51B and Ultra Base Heavy Stack G7-S51BH

	PRODUCT DIMENSIONS (L X W X H)						PRODUCT WEIGHT		WEIGHT STACK	
	CM		INCHES				KG	LBS	KG	LBS
<b>G7-S51</b>	139	121	147	54.6	47.5	57.9	290	640	108	240



### BACK EXTENSION

Multi-position foot placement accommodates a variety of users • Thumb-switch controls allow easy adjustments • Contoured back pad enhances user comfort and provides additional support • Available as Ultra Base G7-S52B and Ultra Base Heavy Stack G7-S52BH

	PRODUCT DIMENSIONS (L X W X H)						PRODUCT WEIGHT		WEIGHT STACK	
	CM		INCHES				KG	LBS	KG	LBS
<b>G7-S52</b>	145	120	135	57.2	47.3	53	316.1	697	108	240



### ROTARY TORSO

Knelling position minimizes low-back stress while stretching hip flexors • Contoured knee pads with wear covers enhance comfort, stability and durability • Oversized handlebars accommodate a variety of users without adjustment • Knee pad wear cover improves upholstery performance in high contact areas • Range of motion feature with 8 different start positions adds greater versatility • Available as Ultra Base G7-S55B and Ultra Base Heavy Stack G7-S55BH

	PRODUCT DIMENSIONS (L X W X H)						PRODUCT WEIGHT		WEIGHT STACK	
	CM		INCHES				KG	LBS	KG	LBS
<b>G7-S55</b>	117	123	141	45.8	48.2	55.2	229	505	90	200



## LEG PRESS

Angled and adjustable seat carriage enhances comfort • Ergonomic adjustment handle and gas shock enable simple changes in start position • Oversized foot platform increases movement variety including calf exercises • Integrated assistance handle enables easy exit and entry • Guide rod and bearing-designed carriage improves long-term durability and smooth performance • Available as Ultra Base G7-S70B and Ultra Base Heavy Stack G7-S70BH

	PRODUCT DIMENSIONS (L X W X H)						PRODUCT WEIGHT		WEIGHT STACK	
	CM			INCHES			KG	LBS	KG	LBS
<b>G7-S70</b>	206	113	152	80.9	44.3	59.9	440	970	180	400



## LEG EXTENSION

Self-adjusting tibia pad for greater ease of use • Soft contoured knee pad provides optimal comfort behind user's knee during use • Thumb-switch controls and ergonomic adjustment handle allow easy user setup • Angled seat and back pads encourage full quadriceps contraction • Pivot location clearly marked to encourage correct knee alignment • Available as Ultra Base G7-S71B and Ultra Base Heavy Stack G7-S71BH

	PRODUCT DIMENSIONS (L X W X H)						PRODUCT WEIGHT		WEIGHT STACK	
	CM			INCHES			KG	LBS	KG	LBS
<b>G7-S71</b>	152.4	125.9	135	60	49.6	53	299.7	661	108	240





### SEATED LEG CURL

Back pad, tibia pad and range-of-motion adjustments are easily accessible from a seated position • Angled seat and unique pivot location encourage full hamstring contraction • Gas-assisted adjustable thigh pad and thumb switch control allow easy user setup • Soft contoured thigh pad provides optimal comfort during use • Available as Ultra Base G7-S72B and Ultra Base Heavy Stack G7-S72BH

	PRODUCT DIMENSIONS (L X W X H)						PRODUCT WEIGHT		WEIGHT STACK	
	CM	INCHES				KG	LBS	KG	LBS	
<b>G7-S72</b>	148.5	117	135	58.4	46	53	314.7	694	90	200



### PRONE LEG CURL

Contoured elbow pads enhance stabilization and comfort • Divergent pad angle eliminates lower-back stress • Integrated sweat guard protects frame from damage • Thumb-switch controls allow easy adjustments • Available as Ultra Base G7-S73B and Ultra Base Heavy Stack G7-S73BH

	PRODUCT DIMENSIONS (L X W X H)						PRODUCT WEIGHT		WEIGHT STACK	
	CM	INCHES				KG	LBS	KG	LBS	
<b>G7-S73</b>	173	112	135	68	44	53	271.5	598.5	90	200



### HIP ADDUCTOR

Ergonomic adjustment handle enables simple changes in start position • Foot pegs and contoured knee pads provide user stabilization and support • Adjustable reclining position offers customized lumbar comfort • Integrated foot platform allows easy exit and entry • Available as Ultra Base G7-S74B and Ultra Base Heavy Stack G7-S74BH

	PRODUCT DIMENSIONS (L X W X H)			PRODUCT WEIGHT		WEIGHT STACK	
	CM	INCHES		KG	LBS	KG	LBS
<b>G7-S74</b>	182	173	135	71.6	67.8	53	270.2 596 90 200



### HIP ABDUCTOR

Ergonomic adjustment handle enables simple changes in start position • Foot pegs and contoured knee pads provide user stabilization and support • Adjustable reclining position offers customized lumbar comfort • Integrated foot platform allows easy exit and entry • Available as Ultra Base G7-S75B and Ultra Base Heavy Stack G7-S75BH

	PRODUCT DIMENSIONS (L X W X H)			PRODUCT WEIGHT		WEIGHT STACK	
	CM	INCHES		KG	LBS	KG	LBS
<b>G7-S75</b>	182	173	135	71.6	68	53	272.2 600 90 200



### CALF EXTENSION

Angled seat position provides greater lumbar support • Ergonomic adjustment handle enables simple changes in start position • Range-of-motion adjustment accommodates a variety of users and start positions • Guide rod and bearing-designed carriage improves long-term durability and smooth performance • Available as Ultra Base G7-S77B and Ultra Base Heavy Stack G7-S77BH

	PRODUCT DIMENSIONS (L X W X H)					PRODUCT WEIGHT		WEIGHT STACK		
	CM	CM	CM	INCHES	INCHES	KG	LBS	KG	LBS	
<b>G7-S77</b>	169	120	150	66.5	47.2	59	291	642	180	400



### GLUTE

Upright user position increases comfort and machine approachability • Rotating foot pad provides stable and smooth contact throughout the full range of motion • Oversized foot platform bolsters stability • Adjustable chest pad accommodates a variety of users • Available as Ultra Base G7-S78B and Ultra Base Heavy Stack G7-S78BH

	PRODUCT DIMENSIONS (L X W X H)					PRODUCT WEIGHT		WEIGHT STACK		
	CM	CM	CM	INCHES	INCHES	KG	LBS	KG	LBS	
<b>G7-S78</b>	200.5	90	156	79	35.3	61.5	232	511	63	140



### HIP THRUST

Closely mimics bar hip thrusting while removing the difficulty, danger and discomfort of a standard Olympic bar exercise • Floating hip pad maintains correct position during exercise • Oversized foot platform bolsters stability and provides consistent positioning

	PRODUCT DIMENSIONS (L X W X H)					PRODUCT WEIGHT		WEIGHT STACK		
	CM	CM	CM	INCHES	INCHES	KG	LBS	KG	LBS	
<b>G7-S79</b>	175	149.5	135	69	59	53	384	847	189	420

## ULTRA STANDARD FRAME AND UPHOLSTERY COLORS

### Iced Silver frames

Obsidian Black – Upholstery



Graphite Gray – Upholstery



Clay Red – Upholstery



Alloy Gray / Graphite Gray – Upholstery



Slate Blue – Upholstery



Alloy Gray / Hazelnut – Upholstery



### Matte Black frames

Obsidian Black – Upholstery



Graphite Gray – Upholstery



Clay Red – Upholstery



Alloy Gray / Graphite Gray – Upholstery



Slate Blue – Upholstery



Alloy Gray / Hazelnut – Upholstery



NOTE: All specifications are subject to change without notice. Actual products may differ from those pictured in this catalog. Actual product colors may vary from what is shown here.



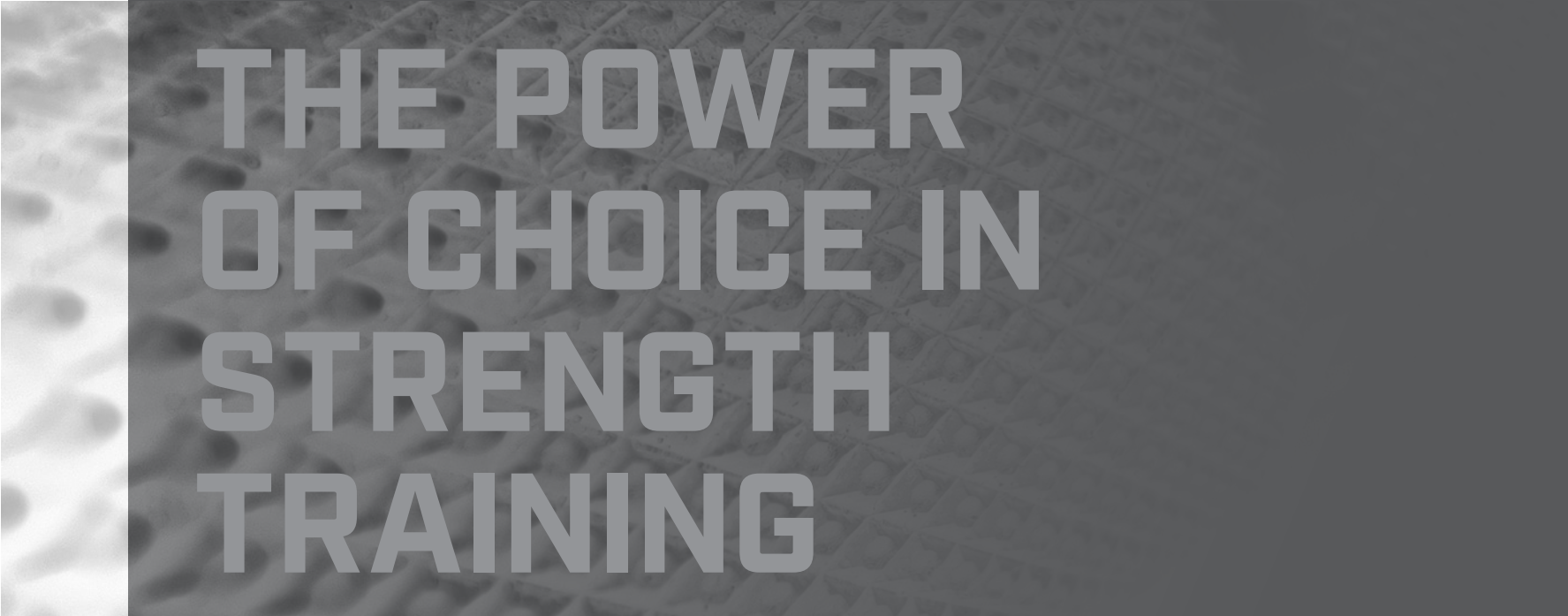

# THE POWER OF CHOICE IN STRENGTH TRAINING

## VERSA series

The Versa Series offers a wide range of options — like standard or heavy weight stacks and optional foot support kits — so you can assemble a collection just right for your space, members and budget. Count on the Versa Series for a mix of advanced biomechanics and smart options that will bring your vision of fitness to life.





# VERSA series

## **ACTION SPECIFIC GRIPS**

Ergonomically designed to reduce stress on contact points while enhancing feel and form. (Versa+ package)

## **CONVERGING/DIVERGING MOTION**

Encourages a natural path of motion to enhance comfort.

## **INCREMENTAL WEIGHTS**

Easy to access and reference from the seated position.

## **GAS-ASSISTED SEAT ADJUSTMENT**

Offers smooth, instant adjustment, with a 4-bar linkage for increased stability. (Versa+ package)

## **ELECTRONIC REP COUNTER**

Tracks reps, activity time and rest time for a streamlined workout experience. (Versa+ package)

## **EXERCISE PLACARDS**

Easy-to-read reference cards highlight targeted muscle groups and proper machine use.





## VERSA OPTIONS

### VERSA+

(shown throughout brochure)

Comes with:

- Action Specific Grips
- Gas-assisted Seat Adjustment
- Electronic Rep Counter/Timer
- Decorative Top Wing
- Ergonomic Adjustment Handles
- Heavy Weight Stack
- Incremental Weight

### WEIGHT STACK

- Choose between Standard and Heavy Weight Stack

### OPTIONAL FOOT SUPPORT KIT

Available on:

- Converging Chest Press
- Converging Shoulder Press
- Biceps Curl
- Back Extension





### CONVERGING CHEST PRESS

Independent converging movement provides a natural path of motion • Designed for easy entry and exit • Adjustable start position facilitates increased range of motion

	PRODUCT DIMENSIONS (L X W X H)					PRODUCT WEIGHT		WEIGHT STACK		
	CM	INCHES				KG	LBS	KG	LBS	
<b>VS-S13</b>	139.3	134.7	160.8	54.9	53	63.3	230	508	72	160
<b>VS-S13P</b>	139.3	134.7	167.1	54.9	53	65.8	265	584	104	230
<b>VS-S13H</b>	139.3	134.7	160.8	54.9	53	63.3	262	578	104	230

### CONVERGING SHOULDER PRESS

Independent converging movement provides a natural path of motion • Dual-position hand grips allow for greater training variety • Counterbalanced pressing arms provide reduced starting resistance

	PRODUCT DIMENSIONS (L X W X H)					PRODUCT WEIGHT		WEIGHT STACK		
	CM	INCHES				KG	LBS	KG	LBS	
<b>VS-S23</b>	171	143.7	203.6	67.3	56.6	80.1	245	538	72	160
<b>VS-S23P</b>	171	143.7	203.6	67.3	56.6	80.1	279	614	104	230
<b>VS-S23H</b>	171	143.7	203.6	67.3	56.6	80.1	276	608	104	230



### DIVERGING LAT PULLDOWN

Independent diverging movement provides a natural path of motion • Angled seat encourages proper user position • Thigh pad easily adjusts for stability and comfort

	PRODUCT DIMENSIONS (L X W X H)					PRODUCT WEIGHT		WEIGHT STACK		
	CM	INCHES				KG	LBS	KG	LBS	
<b>VS-S33</b>	155.4	150.1	187.9	61.2	59.1	74	292	642	72	160
<b>VS-S33P</b>	155.4	150.1	187.9	61.2	59.1	74	334	735	104	230
<b>VS-S33H</b>	155.4	150.1	187.9	61.2	59.1	74	331	729	104	230



### DIVERGING SEATED ROW

Independent cable movement provides a user-defined path of motion and exercise variety • Adjustable chest pad accommodates users of all sizes • Rotating grips provide maximum comfort and ergonomic hand positioning throughout the range of motion • Integrated foot pegs provide added support during heavy lifts

	PRODUCT DIMENSIONS (L X W X H)					PRODUCT WEIGHT		WEIGHT STACK		
	CM	INCHES				KG	LBS	KG	LBS	
<b>VS-S34</b>	137.8	99.4	160.8	54.2	39.1	63.3	214	471	72	160
<b>VS-S34P</b>	137.8	99.4	167.1	54.2	39.1	65.8	249	547	104	230
<b>VS-S34H</b>	137.8	99.4	160.8	54.2	39.1	63.3	246	541	104	230

\*Products shown as Versa+



## BICEPS CURL

Arm pad is angled for stability and limits unwanted shoulder movement during exercise • Optimized pivot location creates biomechanically correct range of motion

	PRODUCT DIMENSIONS (L X W X H)					PRODUCT WEIGHT		WEIGHT STACK		
	CM	INCHES				KG	LBS	KG	LBS	
<b>VS-S40</b>	121.8	127	160.8	48	50	63.3	216	475	68	150
<b>VS-S40P</b>	121.8	127	167.1	48	50	65.8	242	531	90	200
<b>VS-S40H</b>	121.8	127	160.8	48	50	63.3	239	525	90	200

## TRICEPS PRESS

Rotating handles adapt to users of all sizes • Angled back pad reduces stress, improves stabilization and enhances comfort

	PRODUCT DIMENSIONS (L X W X H)					PRODUCT WEIGHT		WEIGHT STACK		
	CM	INCHES				KG	LBS	KG	LBS	
<b>VS-S42</b>	157.7	107.5	160.8	62.1	42.3	63.3	256	564	72	160
<b>VS-S42P</b>	157.7	107.5	167.1	62.1	42.3	65.8	291	640	104	230
<b>VS-S42H</b>	157.7	107.5	160.8	62.1	42.3	63.3	288	634	104	230



### BACK EXTENSION

Multi-position foot placement accommodates a variety of users • Contoured back pad enhances comfort

	PRODUCT DIMENSIONS (L X W X H)				PRODUCT WEIGHT		WEIGHT STACK			
	CM	INCHES			KG	LBS	KG	LBS		
<b>VS-S52</b>	133.5	126.4	160.8	52.6	49.8	63.3	227	500	72	160
<b>VS-S52P</b>	133.5	126.4	167.1	52.6	49.8	65.8	262	576	104	230
<b>VS-S52H</b>	133.5	126.4	160.8	52.6	49.8	63.3	259	570	104	230

### ABDOMINAL

3-position design trains abdominals and obliques for added exercise variety and core rotation • Ergonomic back pad improves range of motion and enhances comfort

	PRODUCT DIMENSIONS (L X W X H)				PRODUCT WEIGHT		WEIGHT STACK			
	CM	INCHES			KG	LBS	KG	LBS		
<b>VS-S53</b>	136.6	141.4	160.8	53.8	55.7	63.3	197	433	72	160
<b>VS-S53P</b>	136.6	141.4	167.1	53.8	55.7	65.8	232	509	104	230
<b>VS-S53H</b>	136.6	141.4	160.8	53.8	55.7	63.3	229	503	104	230

\*Products shown as Versa+



## LEG PRESS/CALF PRESS

One-handed start adjustment for ease of use • Gas-assisted foot platform provides smoother adjustments • Assistance handle and low step-over height offer easy access • Foot plate identifies user foot position with unique visual indicators

	PRODUCT DIMENSIONS (L X W X H)						PRODUCT WEIGHT		WEIGHT STACK	
	CM	INCHES					KG	LBS	KG	LBS
<b>VS-S70</b>	232.4	102.4	160.8	91.5	40.3	63.3	361	795	188	415
<b>VS-S70P</b>	232.4	102.4	167.1	91.5	40.3	65.8	364	801	188	415
<b>VS-S70H</b>	232.4	102.4	160.8	91.5	40.3	63.3	361	795	188**	415**



## LEG EXTENSION

Angled seat and back pads encourage full quadriceps contraction • Self-adjusting tibia pad enhances comfort • Pivot location is clearly marked to encourage correct alignment • Back pad ratchets forward for easy adjustment from seated position

	PRODUCT DIMENSIONS (L X W X H)						PRODUCT WEIGHT		WEIGHT STACK	
	CM	INCHES					KG	LBS	KG	LBS
<b>VS-S71</b>	183.5	128.9	160.8	72.3	50.7	63.3	243	536	72	160
<b>VS-S71P</b>	183.5	128.9	167.1	72.3	50.7	65.8	278	612	104	230
<b>VS-S71H</b>	183.5	128.9	160.8	72.3	50.7	63.3	275	606	104	230



### SEATED LEG CURL

Angled seat and unique pivot location encourage full hamstring contraction • Tibia pad and range-of-motion adjustments are easily accessible from seated position • Back pad ratchets forward for easy adjustment from seated position • Adjustable thigh pad provides stabilization during exercise

	PRODUCT DIMENSIONS (L X W X H)						PRODUCT WEIGHT		WEIGHT STACK	
	CM		INCHES				KG	LBS	KG	LBS
<b>VS-S72</b>	176.9	113.3	160.8	69.7	44.6	63.3	253	556	68	150
<b>VS-S72P</b>	176.9	113.3	167.1	69.7	44.6	65.8	278	612	90	200
<b>VS-S72H</b>	176.9	113.3	160.8	69.7	44.6	63.3	275	606	90	200



### GLUTE

Adjustable chest pad accommodates users of all sizes • Low step-height stabilization platform allows for ease of use • Upright user position, contoured elbow pads and large foot pad enhance comfort

	PRODUCT DIMENSIONS (L X W X H)						PRODUCT WEIGHT		WEIGHT STACK	
	CM		INCHES				KG	LBS	KG	LBS
<b>VS-S78</b>	177.8	99.9	160.8	70	39.3	63.3	185	409	68	150
<b>VS-S78P</b>	177.8	99.9	167.1	70	39.3	65.8	188	415	68	150
<b>VS-S78H</b>	177.8	99.9	160.8	70	39.3	63.3	185	409	68**	150**

\*Products shown as Versa+ \*\*VS-S70 and VS-S78 come standard with heavy weight stack



**MORE  
FUNCTION,  
LESS  
SPACE**

## VERSA DUALS

The expanded versatility of our dual stations makes it easy to create a weight-training collection just right for your space, your budget and the people you serve. By mixing and matching a range of our two-in-one stations, you can make the most of your floor space while providing a complete strength training experience. Intuitive adjustment, incremental weight control and clearly illustrated placards make it easy for users of all ability levels to smoothly transition from one exercise to the next, while ergonomic design adds comfort to every workout. Choose from eight dual-station units, customize with weight stack options or our premium Versa+ package, and complete your offering with more Versa single-station units.







### MULTI-PRESS

Designed for easy entry and exit • Smoothly transition between exercises with one simple adjustment • Dual-position hand grips allow for greater training variety • Elevated foot rests provide stability and comfort during heavy lifts • Reclined position offers greater lumbar support • Clearly indicated adjustments for ease of use

	PRODUCT DIMENSIONS (L X W X H)					PRODUCT WEIGHT		WEIGHT STACK		
	CM	INCHES				KG	LBS	KG	LBS	
<b>VS-S131</b>	154.3	157.2	199.9	60.7	61.9	78.7	236	520	72	160
<b>VS-S131P</b>	154.3	157.2	199.9	60.7	61.9	78.7	271	596	104	230
<b>VS-S131H</b>	154.3	157.2	199.9	60.7	61.9	78.7	268	590	104	230

### REAR DELT / PEC FLY

Comfortable, oversized grips accommodate users of all sizes • Always forward-facing user position enhances comfort and ease of use • Wide motion for improved biomechanics and dual function

	PRODUCT DIMENSIONS (L X W X H)					PRODUCT WEIGHT		WEIGHT STACK		
	CM	INCHES				KG	LBS	KG	LBS	
<b>VS-S22</b>	150.5	169	160.8	59.2	66.5	63.3	224	492	68	150
<b>VS-S22P</b>	150.5	169	167.1	59.2	66.5	65.8	259	548	90	200
<b>VS-S22H</b>	150.5	169	160.8	59.2	66.5	63.3	256	542	90	200



### LAT PULLDOWN / SEATED ROW

Thigh pad easily adjusts to provide stability and comfort • Elevated foot-rests provide stability and comfort during heavy lifts • Stainless-steel cable guides provide added protection for lasting durability • Clearly indicated adjustments for ease of use

	PRODUCT DIMENSIONS (L X W X H)				PRODUCT WEIGHT		WEIGHT STACK			
	CM	INCHES	KG	LBS	KG	LBS	KG	LBS		
<b>VS-S331</b>	180.5	157.9	226.3	71.1	62.2	89.1	246	543	72	160
<b>VS-S331P</b>	180.5	157.9	226.3	71.1	62.2	89.1	281	619	104	230
<b>VS-S331H</b>	180.5	157.9	226.3	71.1	62.2	89.1	278	613	104	230

### BICEPS / TRICEPS

Compact design minimizes floor space • Stainless-steel cable guides provide added protection for lasting durability • Large foot platform provides stability

	PRODUCT DIMENSIONS (L X W X H)				PRODUCT WEIGHT		WEIGHT STACK			
	CM	INCHES	KG	LBS	KG	LBS	KG	LBS		
<b>VS-S401</b>	166.6	124.7	226.2	65.6	49.1	89.1	214	472	68	150
<b>VS-S401P</b>	166.6	124.7	226.2	65.6	49.1	89.1	240	528	90	200
<b>VS-S401H</b>	166.6	124.7	226.2	65.6	49.1	89.1	237	522	90	200

\*Products shown as Versa+



## AB / LOW BACK

Angled seat and lumbar pad enhance user comfort • Multi-position foot placement accommodates a variety of users • Low handle positions offer easy entry and exit and provide stability • Clearly indicated adjustments for ease of use

	PRODUCT DIMENSIONS (L X W X H)						PRODUCT WEIGHT		WEIGHT STACK	
	CM		INCHES				KG	LBS	KG	LBS
<b>VS-S531</b>	132.2	131.5	160.8	52.1	51.8	63.3	231	509	72	160
<b>VS-S531P</b>	132.2	131.5	167.1	52.1	51.8	65.8	266	585	104	230
<b>VS-S531H</b>	132.2	131.5	160.8	52.1	51.8	63.3	263	579	104	230



## CHIN / DIP ASSIST

Multi-position pull-up handles for greater exercise variety • Ideally angled dip grips encourage proper wrist placement and muscle variation • Gas-assisted knee platform folds up for unassisted bodyweight exercises and training variety • Large, textured foot platforms provide easy entry and exit • Knee platform features a protective top pad for added training security • Integrated hard stop prevents knee pad disengagement • Clearly indicated adjustments for ease of use

	PRODUCT DIMENSIONS (L X W X H)						PRODUCT WEIGHT		WEIGHT STACK	
	CM		INCHES				KG	LBS	KG	LBS
<b>VS-S601</b>	142.8	152.8	219.7	56.2	60.2	86.5	307	676	68**	150**
<b>VS-S601P</b>	142.8	152.8	219.7	56.2	60.2	86.5	310	682	68**	150**
<b>VS-S601H</b>	142.8	152.8	219.7	56.2	60.2	86.5	307	676	68**	150**



### LEG EXTENSION / LEG CURL

Angled pads and ideal pivot location promote full muscle contraction and alignment for both exercises • Dual-action CAM enables a smooth transition between exercises and prevents cable slack • Adjustments are easily performed in the seated position • Back pad ratchets forward for easy adjustment from the seated position • Clearly indicated adjustments for ease of use

	PRODUCT DIMENSIONS (L X W X H)						PRODUCT WEIGHT		WEIGHT STACK	
	CM		INCHES				KG	LBS	KG	LBS
<b>VS-S711</b>	177.6	118.3	160.8	69.9	46.6	63.3	251	554	72	160
<b>VS-S711P</b>	177.6	118.3	167.1	69.9	46.6	65.8	286	630	104	230
<b>VS-S711H</b>	177.6	118.3	160.8	69.9	46.6	63.3	283	624	104	230



### HIP ADDUCTOR / ABDUCTOR

Dual-function machine saves space and increases functionality • Reclined position provides greater comfort • Clearly indicated adjustments allow for ease of use

	PRODUCT DIMENSIONS (L X W X H)						PRODUCT WEIGHT		WEIGHT STACK	
	CM		INCHES				KG	LBS	KG	LBS
<b>VS-S74</b>	169.6	159.1	160.8	66.8	62.6	63.3	235	516	72	160
<b>VS-S74P</b>	169.6	159.1	167.1	66.8	62.6	65.8	269	592	104	230
<b>VS-S74H</b>	169.6	159.1	160.8	66.8	62.6	63.3	266	586	104	230

\*Products shown as Versa+ \*\*VS-601 comes standard with heavy weight stack

## MD LEG PRESS

Ideal for creating a wide range of progression programs, including isometric, loaded isometric, isotonic, plyometric, elastic and combined (elastic and weight stack) exercises • Low starting weight offers gradual progression • Adjustable shoulder pads and gas-assisted seat back provide flexible progressions and comfortable use for clients of all sizes • Stack disconnect allows free movement of the carriage without additional resistance, ideal for deconditioned and injured clients • Band hooks make it easy to add external resistance bands for elastic and plyometric training • Carriage lockout and range-of-motion limiter restrict carriage movement for isometric contractions while protecting clients from overextending

Also available: optional incremental weights, step stool, force plate holder and MD-S70-AP accessory package



WEDGE BLOCK / HEEL CUP / ACCESSORY CRADLE / STOOL



	PRODUCT DIMENSIONS (L X W X H)						PRODUCT WEIGHT		WEIGHT STACK	
	CM	CM	CM	INCHES	INCHES	INCHES	KG	LBS	KG	LBS
<b>MD-S70</b>	263.2	121.9	188.3	103.7	48	74.2	372	820	136	300



### MD LEG EXTENSION / CURL

Ideal for creating a wide range of progression programs including exercises that build strength in the hamstrings and quads • Unique seat pivot allows proper joint alignment creating optimal biomechanics in both directions • Gas-assisted adjustments combined with a rotating thigh pad for open exit and entry provide an exceptional user experience • The range-of-motion limiter and 12 starting positions allow complete control over stroke length and isometric contractions • Low starting weight of 4.5 kg / 10 lbs. for the leg extension and 3.4 kg / 7.5 lbs. for the leg curl • Also available: optional incremental weights and step stool

	PRODUCT DIMENSIONS (L X W X H)						PRODUCT WEIGHT		WEIGHT STACK	
	CM	INCHES	KG	LBS	KG	LBS	KG	LBS		
<b>MD-S711</b>	165.4	125.4	162.5	65.2	49.4	64	340	750	91	200



### MD ADJUSTABLE PULLEY

Ideal for creating a wide range of progression programs including exercises that build upper body, lower body and core muscles that are essential to ADLs • 35 clearly numbered adjustment points provide exercise variety • Low starting weight of 2.3 kg / 5 lbs. offers gradual progression • 1:2 pulley ratio provides smooth operation • Also available: optional incremental weight, balance bar, medical handrail, wheel transport and Inclusive Fitness kit

	PRODUCT DIMENSIONS (L X W X H)						PRODUCT WEIGHT		WEIGHT STACK	
	CM	INCHES	KG	LBS	KG	LBS	KG	LBS		
<b>MD-AP</b>	107.2	125	228	42.2	49.3	89.8	174	384	68	150

\*Products shown with optional accessories.



# SPACE-SAVING VERSATILITY

## VERSA FUNCTIONAL TRAINER

The smart design of our functional trainer provides a remarkable range of exercise options in a space-saving footprint. Incremental weight adjustment and a 1:2 pulley ratio make it easy to control exercise intensity and create progressions right for everyone from deconditioned users to elite athletes. Everything about our functional trainer — from the multi-grip pull-up bar to the color-coded adjustment points to the professionally illustrated exercise placards — offers intuitive operation for users and trainers alike. Optional storage makes it easy to organize and stow accessories for instant access, and the completely enclosed design protects the unit's moving parts while creating a solid, cohesive aesthetic on your floor.





FTS18

FTS30

## FUNCTIONAL TRAINER

Multi-position pull-up handles for greater exercise variety • Fully-enclosed weight stacks protect the machine's internal components • Enhanced placards highlight targeted muscle groups and proper user positioning for a wide range of exercises • One-handed pulley adjustment offers easy operation • Frame guards protect against chips and scratches • Clearly indicated adjustments for ease of use • Compact design accommodates placement in spaces with ceilings as low as 2.4 m / 8' • 76 cm / 30" connection provides ample storage for functional training accessories or 46 cm / 18" connection to accommodate optional training handles • 1:2 pulley ratio provides smooth operation • Standard effective resistance 34 kg / 75 lbs. (per side)

### Optional:

- VS-VFT60 heavy stack for added 13.6 kg / 30 lbs. of resistance per side for 47.6 kg / 105 lbs. effective resistance
- Accessory: VS-FTHP handle package includes four training handles (v-bar, curl bar, ropes, ankle strap)
- VS-FTIW 2.3 kg / 5 lb. increment weight (effective resistance 1.1 kg / 2.5lb.)

	PRODUCT DIMENSIONS (L X W X H)					PRODUCT WEIGHT		WEIGHT STACK		
	CM		INCHES			KG	LBS	KG	LBS	
<b>VS-VFT-S18</b>	111.8	160.0	237.6	44.0	63	93.5	355	782	68	150
<b>VS-VFT-S30</b>	122.7	145.8	237.6	48.3	57.4	93.5	369	814	68	150
<b>VS-VFT-S18 + VS-VFT60</b>	111.8	160.0	237.6	44.0	63	93.5	409	902	95	210
<b>VS-VFT-S30 + VS-VFT60</b>	122.7	145.8	237.6	48.3	57.4	93.5	424	934	95	210

\*Accessories not included.

## VERSA STANDARD FRAME AND UPHOLSTERY COLORS

### Iced Silver frames

Obsidian Black – Upholstery



Clay Red – Upholstery



Slate Blue – Upholstery



### Matte Black frames

Obsidian Black – Upholstery



Clay Red – Upholstery



Slate Blue – Upholstery



NOTE: All specifications are subject to change without notice. Actual products may differ from those pictured in this catalog. Actual product colors may vary from what is shown here.



# THE STANDARD IN PERFORMANCE AND DESIGN

## AURA series

Superior styling made the Aura Series an instant classic. Signature features made it one of the most-imitated product lines in the industry. Choose the Aura Series, and you'll discover that beginners and fitness enthusiasts alike will be drawn to something that the competition can't imitate — an unmistakable aura of greatness.





# AURA **series**

A superior blend of features and sophistication, the Aura Series appeals to fitness enthusiasts of all kinds. Independent converging and diverging motions on select units provide a natural resistance movement that feels smooth and natural. Ergo Form cushions ensure proper body alignment and support while introducing an extra touch of style. In addition to offering a unique aesthetic distinction that attracts users, our round-tube construction with automotive-quality powder-coat finish provides lasting strength and durability.



**FRAME AND FINISH**

Attractive round-tube construction provides unmatched strength, and automotive-quality finish is highly resistant to chips and scratches.

**ERGO FORM CUSHIONS**

Uniquely attractive design ensures proper body alignment and support.

**INCREMENTAL WEIGHTS**

Easy to access and reference from the seated position.

**CONVERGING/DIVERGING MOTION**

Encourages a natural path of motion to enhance comfort

**BOTTLE AND TOWEL HOLDER**

Conveniently positioned to prevent spills and clutter on your floor.

**COLOR-CODED EXERCISE PLACARDS**

Easy-to-read reference cards highlight targeted muscle groups and proper machine use.





### CHEST PRESS

Adjustable pressing arm allows users to determine their own range of motion • Oversized, dual-position hand grips provide greater comfort and variety

	PRODUCT DIMENSIONS (L X W X H)						PRODUCT WEIGHT		WEIGHT STACK	
	CM			INCHES			KG	LBS	KG	LBS
<b>G3-S10</b>	127	155.9	184.7	50	61.4	72.7	275	607	113	250



### PECTORAL FLY

Dual hand grips accommodate users of all sizes • Independent arm action ensures more balanced exercise by not allowing the dominant side to control the exercise • Adjustable starting position allows for greater range of motion

	PRODUCT DIMENSIONS (L X W X H)						PRODUCT WEIGHT		WEIGHT STACK	
	CM			INCHES			KG	LBS	KG	LBS
<b>G3-S12</b>	113.3	156.8	150.6	44.6	61.7	59.3	246	542	91	200





### CONVERGING CHEST PRESS

Independent converging motion arms • Dual hand-grip positions provide greater training variety • Designed for easy entry and exit

	PRODUCT DIMENSIONS (L X W X H)						PRODUCT WEIGHT		WEIGHT STACK	
	CM		INCHES				KG	LBS	KG	LBS
<b>G3-S13</b>	128.3	155.1	174.8	50.5	61.1	68.8	293	645	113	250



### SHOULDER PRESS

Dual-position hand grips allow for greater training variety • Oversized hand grips provide improved function and comfort • Counterbalanced pressing arm provides reduced starting resistance

	PRODUCT DIMENSIONS (L X W X H)						PRODUCT WEIGHT		WEIGHT STACK	
	CM		INCHES				KG	LBS	KG	LBS
<b>G3-S20</b>	152	146.9	150.7	59.8	57.8	59.3	251	553	91	200



### LATERAL RAISE

Independent arm action ensures balanced exercise • Handles pivot to accommodate users of all sizes

	PRODUCT DIMENSIONS (L X W X H)							PRODUCT WEIGHT		WEIGHT STACK	
	CM			INCHES				KG	LBS	KG	LBS
<b>G3-S21</b>	154.2	152.4	150.6	60.7	60	59.3	271	597	91	200	



### REAR DELT / PEC FLY

User arms pivot to accommodate individual forearm lengths and varying paths of motion • Optimized handle positions reduce the need to adjust the seat position between rear deltoid and fly exercises

	PRODUCT DIMENSIONS (L X W X H)							PRODUCT WEIGHT		WEIGHT STACK	
	CM			INCHES				KG	LBS	KG	LBS
<b>G3-S22</b>	189	195.5	205	74.5	77	81	288.5	636	134	295	



### CONVERGING SHOULDER PRESS

Independent converging motion arms • Pressing arm includes both standard and neutral grips for user preference • Oversized hand grips provide greater comfort and variety

	PRODUCT DIMENSIONS (L X W X H)						PRODUCT WEIGHT		WEIGHT STACK	
	CM		INCHES				KG	LBS	KG	LBS
<b>G3-S23</b>	153.8	149.3	173.6	60.6	58.8	68.4	251	553	91	200



### LAT PULLDOWN

Thigh pads easily adjust to provide both stability and comfort • Straight bar with angled ends ensures correct arm and wrist position throughout the entire range of motion

	PRODUCT DIMENSIONS (L X W X H)						PRODUCT WEIGHT		WEIGHT STACK	
	CM		INCHES				KG	LBS	KG	LBS
<b>G3-S30</b>	139.5	120	221.5	55	47	87	245	540	134	295



### SEATED ROW

Dual-position hand grips allow for greater training variety • Optimized pivot location creates a biomechanically correct arc of motion

	PRODUCT DIMENSIONS (L X W X H)						PRODUCT WEIGHT		WEIGHT STACK	
	CM		INCHES				KG	LBS	KG	LBS
<b>G3-S31</b>	151.4	92.1	210.6	59.6	36.3	82.9	273	601	113	250



### DIVERGING LAT PULLDOWN

Independent diverging motion arms • Angled seat cues optimal user position • High pads easily adjust to provide both stability and comfort

	PRODUCT DIMENSIONS (L X W X H)						PRODUCT WEIGHT		WEIGHT STACK	
	CM		INCHES				KG	LBS	KG	LBS
<b>G3-S33</b>	146.7	88.4	211.7	57.8	34.8	83.3	237	527	113	250



### DIVERGING SEATED ROW

Independent diverging motion arms • Dual-position hand grips provide greater training variety

	PRODUCT DIMENSIONS (L X W X H)						PRODUCT WEIGHT		WEIGHT STACK	
	CM		INCHES				KG	LBS	KG	LBS
<b>G3-S34</b>	154.4	87.9	198.7	60.8	34.6	78.2	259	570	113	250



### ARM CURL

Arm pad is angled for stability and limits unwanted shoulder movement during exercise • Angled rotating hand grips ensure optimal wrist position

	PRODUCT DIMENSIONS (L X W X H)						PRODUCT WEIGHT		WEIGHT STACK	
	CM		INCHES				KG	LBS	KG	LBS
<b>G3-S40</b>	122	108.6	150.6	48.1	42.8	59.3	228	502	91	200



### TRICEPS PRESS

Rotating handles adapt to users of all sizes • Over-molded grips ensure a secure, non-slip feel • Angled back pad reduces stress, improves stabilization and enhances comfort

	PRODUCT DIMENSIONS (L X W X H)						PRODUCT WEIGHT		WEIGHT STACK	
	CM		INCHES				KG	LBS	KG	LBS
<b>G3-S42</b>	158.8	128	173.6	62.5	50.4	68.4	261	575	91	200



### TRICEPS EXTENSION

Seat and upper-arm pads are angled to enhance user stability during exercise • Handle pivots adjust for varying forearm lengths

	PRODUCT DIMENSIONS (L X W X H)						PRODUCT WEIGHT		WEIGHT STACK	
	CM		INCHES				KG	LBS	KG	LBS
<b>G3-S45</b>	117.4	108.4	150.6	46.2	42.7	59.3	223	491	91	200



### ABDOMINAL

Hand grips and contoured-edge chest pad enhance comfort • Adjustable resistance arm allows users to determine their own starting positions

	PRODUCT DIMENSIONS (L X W X H)					PRODUCT WEIGHT		WEIGHT STACK		
	CM	INCHES				KG	LBS	KG	LBS	
<b>G3-S50</b>	137	94	150	54	37	59	184	405	68	150



### ABDOMINAL CRUNCH

Dual axis of rotation enhances user feel for a natural crunch movement and muscle contraction • Seat and handle positions enhance user stability

	PRODUCT DIMENSIONS (L X W X H)						PRODUCT WEIGHT		WEIGHT STACK	
	CM	INCHES		CM	INCHES		KG	LBS	KG	LBS
<b>G3-S51</b>	142.8	112.2	150.5	56.2	44.2	59.3	184	405	91	200



### BACK EXTENSION

Adjustable nonskid footrests provide secure and proper positioning • Lower-back reference pad encourages proper user alignment

	PRODUCT DIMENSIONS (L X W X H)						PRODUCT WEIGHT		WEIGHT STACK	
	CM		INCHES				KG	LBS	KG	LBS
<b>G3-S52</b>	157.7	106.5	174.9	62.1	41.9	68.9	277	610	134	295



### ROTARY TORSO

Unique design reinforces proper user positioning • Range of motion is adjustable in 10-degree increments • Foot bar helps users of all sizes achieve proper stabilization

	PRODUCT DIMENSIONS (L X W X H)						PRODUCT WEIGHT		WEIGHT STACK	
	CM		INCHES				KG	LBS	KG	LBS
<b>G3-S55</b>	164.2	97	173.7	64.6	38.2	68.4	216	476	91	200





## DIP / CHIN ASSIST

Rotating dip handles adapt to users of all sizes • Pull-up bar offers both standard and neutral grips for individual preference • 2 sets of pull-up grips allow users of all heights a full range of motion

	PRODUCT DIMENSIONS (L X W X H)						PRODUCT WEIGHT		WEIGHT STACK	
	CM		INCHES				KG	LBS	KG	LBS
<b>G3-S60</b>	127	106.5	231.5	50	42	91	197	434	68	150





## LEG PRESS

4-bar linkage enhances alignment and provides variable resistance • Large nonskid footplate accommodates users of all sizes

	PRODUCT DIMENSIONS (L X W X H)						PRODUCT WEIGHT		WEIGHT STACK	
	CM		INCHES				KG	LBS	KG	LBS
<b>G3-S70</b>	210.1	124.6	184.6	82.7	49	72.7	417	920	175	385



## LEG EXTENSION

Angled seat and back pads encourage full quadriceps contraction • Adjustable start position facilitates increased range of motion • Self-adjusting tibia pad enhances comfort

	PRODUCT DIMENSIONS (L X W X H)						PRODUCT WEIGHT		WEIGHT STACK	
	CM		INCHES				KG	LBS	KG	LBS
<b>G3-S71</b>	180.5	111.5	175	71	44	69	245.5	542	113	250



### SEATED LEG CURL

Seat, back and tibia pads adjust without affecting knee alignment or start-position angle • Adjustable start position facilitates increased range of motion

	PRODUCT DIMENSIONS (L X W X H)					PRODUCT WEIGHT		WEIGHT STACK		
	CM	INCHES		KG	LBS	KG	LBS	KG	LBS	
<b>G3-S72</b>	180	108	174.5	71	42.5	68.75	248.5	548	93	205



### PRONE LEG CURL

Divergent pad angle eliminates lower-back stress • Standard range of motion adjusts for individual preference

	PRODUCT DIMENSIONS (L X W X H)					PRODUCT WEIGHT		WEIGHT STACK		
	CM	INCHES		KG	LBS	KG	LBS	KG	LBS	
<b>G3-S73</b>	171	111	174.5	67.5	44	68.75	222	489.5	91	200



### HIP ADDUCTOR

Knee pads and dual footrests provide leg support and enhanced comfort • Weight stack positioned in front of the user acts as a shield, providing enhanced privacy

	PRODUCT DIMENSIONS (L X W X H)						PRODUCT WEIGHT		WEIGHT STACK	
	CM		INCHES				KG	LBS	KG	LBS
<b>G3-S74</b>	166.6	164.3	150.8	65.6	64.7	59.4	264	582	100	220



### HIP ABDUCTOR

Knee pads and dual footrests provide leg support to eliminate unwanted torque around the knee • Weight stack positioned in front of the user acts as a shield, providing enhanced privacy

	PRODUCT DIMENSIONS (L X W X H)						PRODUCT WEIGHT		WEIGHT STACK	
	CM		INCHES				KG	LBS	KG	LBS
<b>G3-S75</b>	166.6	107.5	150.8	65.6	42.3	59.4	270	595	100	220



### ROTARY HIP

Standing position provides enhanced alignment and increased target muscle involvement • Adjustable carriage allows users of varying heights to achieve optimal positioning • Starting positions are incremental at 15-degree intervals through 270 degrees of rotation • Low step-up height 13.2 cm / 5.2" for easy entry and exit

	PRODUCT DIMENSIONS (L X W X H)						PRODUCT WEIGHT		WEIGHT STACK	
	CM		INCHES				KG	LBS	KG	LBS
<b>G3-S76</b>	111.7	119.7	184.3	44	47.1	72.6	295	650	134	295



### CALF PRESS

Force is transmitted through hips to eliminate spinal compression • Foot plates are curved for comfortable positioning and a full range of motion • Fully enclosed linear bearings provide smooth, quiet motion

	PRODUCT DIMENSIONS (L X W X H)						PRODUCT WEIGHT		WEIGHT STACK	
	CM		INCHES				KG	LBS	KG	LBS
<b>G3-S77</b>	173	68.9	150.5	68.1	27.1	59.3	304	670	134	295



## FUNCTIONAL TRAINER

1:4 pulley ratio offers low starting resistance and high-speed movements • Available with 132-kg / 290-lb. or 177-kg / 390-lb. stacks • Standard swiveling accessory station includes 10 attachments • Multi-grip-position pull-up handles with unique rock-climbing attachment • Integrated fold-away step offers easy access • G3-MSFT300 effective resistance: 32.9-kg / 72.5-lbs. (per side) • G3-MSFT400 effective resistance: 44.2-kg / 97.5-lbs. (per side)

	PRODUCT DIMENSIONS (L X W X H)						PRODUCT WEIGHT		WEIGHT STACK	
	CM		INCHES				KG	LBS	KG	LBS
<b>G3-MSFT300</b>	169.2	130.2	234.4	66.6	51.2	92.3	601	1324	2 X 131	2 X 290
<b>G3-MSFT400</b>	169.2	130.2	234.4	66.6	51.2	92.3	697	1537	2 X 176	2 X 390



Flanged pulley housing

### ADJUSTABLE CABLE CROSSOVER

Widely spaced, dual-adjustable pulleys offer exercise variety • Pull-up bar with both lat and neutral grips provide hand placement options • One-handed adjustment makes operation easy • Flanged pulley housing minimizes cable wear and increases durability • 1:2 pulley ratio provides smooth operation



	PRODUCT DIMENSIONS (L X W X H)						PRODUCT WEIGHT		WEIGHT STACK	
	CM		INCHES				KG	LBS	KG	LBS
<b>G3-MS20</b>	397.4	90	239.6	156.5	35.4	94.3	399	880	2 X 91	2 X 200

# AURA MULTI-STATION: PRECONFIGURED

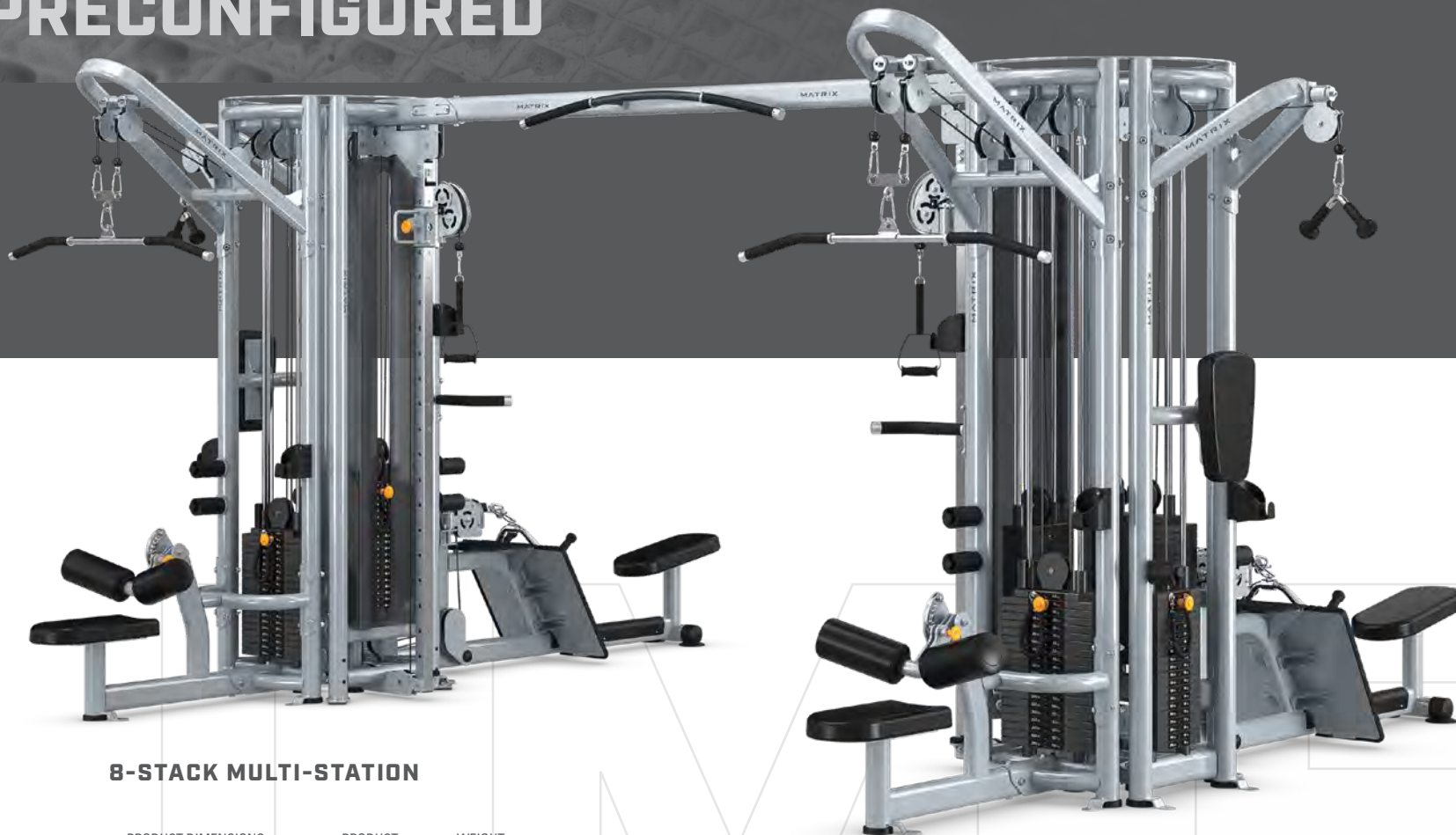

## 8-STACK MULTI-STATION

	PRODUCT DIMENSIONS (L X W X H)					PRODUCT WEIGHT		WEIGHT STACK		
	CM	INCHES	KG	LBS	KG	LBS	KG	LBS		
<b>G3-MS80</b>	561.3	370.9	251.7	221	146	99.1	1996	4400	4 X 91 4 X 134	4 X 200 4 X 295





### 4-STACK MULTI-STATION

	PRODUCT DIMENSIONS (L X W X H)						PRODUCT WEIGHT		WEIGHT STACK	
	CM		INCHES				KG	LBS	KG	LBS
<b>G3-MS40</b>	167.8	369.8	252	66.1	145.6	99.2	998	2200	2 X 91 2 X 134	2 X 200 2 X 295



### 5-STACK MULTI-STATION

	PRODUCT DIMENSIONS (L X W X H)						PRODUCT WEIGHT		WEIGHT STACK	
	CM		INCHES				KG	LBS	KG	LBS
<b>G3-MS50</b>	481.5	369.8	251.7	189.6	145.6	99.1	1197	2640	3 X 91 2 X 134	3 X 200 2 X 295

# AURA MULTI-STATION: CONFIGURE YOUR OWN

Meet the strength training needs of multiple users and maximize training options with the completely customizable Aura Multi-Stations. Create your own combination of the Lat Pulldown (MS51), Adjustable Pulley (MS24), Triceps Pressdown (MS52) and/or Low Row (MS53). One recent Matrix customer even created an impressive 28-stack unit that spans the entire length of their facility for unparalleled versatility and space efficiency.

All units include water bottle holders and towel hooks so essential accessories are easily accessible. In addition to offering a unique aesthetic distinction, our round-tube construction with an automotive-quality powder-coat finish provides lasting strength and durability.

### LAT PULLDOWN

Two independent cables add training variety • Pivoting knee pad allows for quick and easy adjustments



	PRODUCT DIMENSIONS (L X W X H)						PRODUCT WEIGHT		WEIGHT STACK	
	CM		INCHES				KG	LBS	KG	LBS
<b>G3-MS51</b>	140	120	252	55	47.5	99.5	252	556	134	295

### ADJUSTABLE PULLEY

Single-handed height adjustment offers easy use • 1:2 pulley ratio provides smooth movement and smaller incremental weight changes • Balance bar adds support during exercise



	PRODUCT DIMENSIONS (L X W X H)						PRODUCT WEIGHT		WEIGHT STACK	
	CM		INCHES				KG	LBS	KG	LBS
<b>G3-MS24</b>	68	70	240	27	28	94.5	181	398.5	91	200

### TRICEPS PRESSDOWN

Swiveling top pulley enhances durability • 1:1 pulley ratio allows for heavy training • Additional stability pad enhances comfort



	PRODUCT DIMENSIONS (L X W X H)						PRODUCT WEIGHT		WEIGHT STACK	
	CM		INCHES				KG	LBS	KG	LBS
<b>G3-MS52</b>	85	59	240	33.5	23.5	94.5	171.5	377.5	91	200

### LOW ROW

Two independent cables add training variety • Pivoting knee pad allows for quick and easy adjustments



	PRODUCT DIMENSIONS (L X W X H)						PRODUCT WEIGHT		WEIGHT STACK	
	CM		INCHES				KG	LBS	KG	LBS
<b>G3-MS53</b>	230	71	240	91	28	94.5	260	573	134	295

## AURA STANDARD FRAME AND UPHOLSTERY COLORS

### Iced Silver frames

Obsidian Black – Upholstery



Clay Red – Upholstery



Slate Blue – Upholstery



### Matte Black frames

Obsidian Black – Upholstery



Clay Red – Upholstery



Slate Blue – Upholstery



NOTE: All specifications are subject to change without notice. Actual products may differ from those pictured in this catalog. Actual product colors may vary from what is shown here.



# DISCOVER THE STRENGTH OF SIMPLICITY

**GO**  
**series**

Ideal for users new to strength training and circuit programs, Go Series single stations are compact and easy-to-use — creating a welcoming experience. Go Series features back-to-back design, improving traffic flow and making it easy to configure your space. Each single-station unit has a low starting weight and minimal to no adjustments, so users can get started right away.

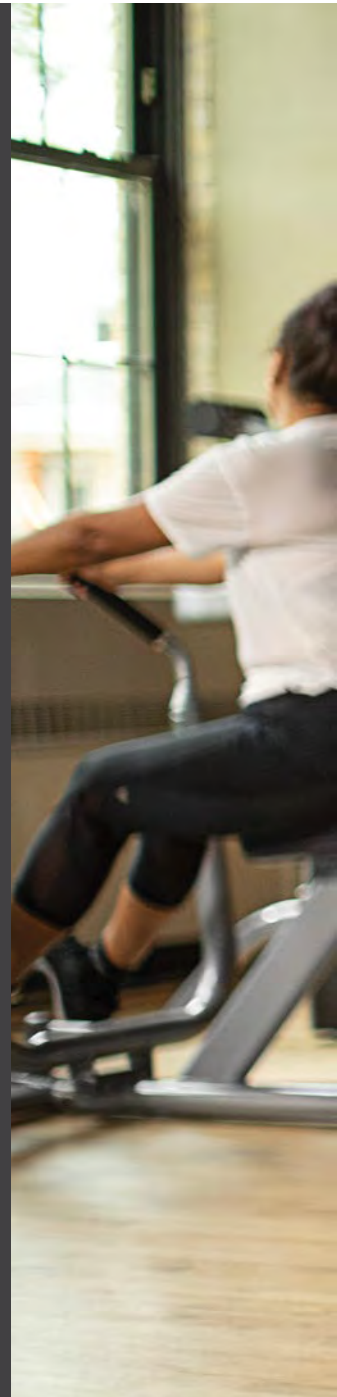



# GO series

## ENHANCED USABILITY

Minimal adjustments, low starting weight and optional incremental weight allows for smaller progressions that keep users of all abilities motivated as they gain strength.

## SPACE-SAVING DESIGN

Compact footprint with back-to-back configurations improves traffic flow and helps you serve more users when space is at a premium and budgets need to stretch further.

## STREAMLINED SERVICE & MAINTENANCE

Guide rods can be removed without any tools, while a durable metal shroud withstands tough environments and can be easily removed to streamline service.

## USER AMENITIES

Storage space on top of stack lets users keep their personal device, water bottle and towel in reach while reducing clutter on your floor.

## EXERCISE PLACARDS

Large, easy-to-read reference cards highlight targeted muscle groups and proper machine use.

## INCREMENTAL WEIGHTS

An optional 2.3-kg / 5-lb. incremental weight allows for smaller progressions that keep users motivated as they gain strength.









### CHEST PRESS

Oversized neutral grips provide a natural, comfortable hold that reduces stress on shoulder joints • Intuitive design with no adjustments needed

	PRODUCT DIMENSIONS (L X W X H)						PRODUCT WEIGHT		WEIGHT STACK	
	CM			INCHES			KG	LBS	KG	LBS
<b>GO-S13</b>	158	118	137	62.2	46.6	54	166	366	72	160



### SHOULDER PRESS

Intuitive design with no adjustments needed • Oversized neutral grips provide a natural, comfortable hold that reduces stress on shoulder joints

	PRODUCT DIMENSIONS (L X W X H)						PRODUCT WEIGHT		WEIGHT STACK	
	CM			INCHES			KG	LBS	KG	LBS
<b>GO-S23</b>	148	110.5	176	58.4	43.5	69.3	160	353	45	100



### LAT PULLDOWN

Ratcheting seat adjusts easily, letting users fine tune the range of motion for optimal comfort and function • Oversized neutral grips offer a comfortable hold while reducing stress on shoulder joints

	PRODUCT DIMENSIONS (L X W X H)						PRODUCT WEIGHT		WEIGHT STACK	
	CM		INCHES				KG	LBS	KG	LBS
<b>GO-S33</b>	174	91	171	68.5	35.8	67.3	210	463	72	160



### SEATED ROW

Oversized angled grips provide a natural, comfortable hold • Dual position foot pegs and an extra-long seat let users of different heights position themselves comfortably with no adjustments needed

	PRODUCT DIMENSIONS (L X W X H)						PRODUCT WEIGHT		WEIGHT STACK	
	CM		INCHES				KG	LBS	KG	LBS
<b>GO-S34</b>	148	123	137	58.3	48.5	54	159	350.5	72	160



## BICEPS CURL

Intuitive design with no adjustments needed • Highlighted pivot point indicates optimal elbow positioning and body alignment • Extended seat lets users shift hip positioning for proper alignment

	PRODUCT DIMENSIONS (L X W X H)						PRODUCT WEIGHT		WEIGHT STACK	
	CM			INCHES			KG	LBS	KG	LBS
<b>GO-S40</b>	125	104	137	49.2	41	54	148	326.5	54	120



## SEATED TRICEPS PRESS

Oversized neutral grips provide a natural, comfortable hold • Seated press motion follows a natural path, reducing stress on elbow joints, engaging the entire upper body and aiding in sit-to-stand progressions • Intuitive design with no adjustments needed

	PRODUCT DIMENSIONS (L X W X H)						PRODUCT WEIGHT		WEIGHT STACK	
	CM			INCHES			KG	LBS	KG	LBS
<b>GO-S42</b>	130.5	101.5	137	51.4	39.9	54	163	359.5	72	160



### ABDOMINAL

Intuitive design with no adjustments needed • Comfortably contoured back pad provides a full range of motion, stretching core muscles in a way traditional flat back pads can't • Soft, oversized grips offer a comfortable hold

	PRODUCT DIMENSIONS (L X W X H)						PRODUCT WEIGHT		WEIGHT STACK	
	CM		INCHES				KG	LBS	KG	LBS
<b>GO-S53</b>	158	94.5	137	62.2	37.2	54	150.5	332	63	140



### LEG PRESS

Low step-in height offers easy entry and exit • Clearly numbered adjustment points make each user's starting point easily identifiable and repeatable for faster starts • Large rubber foot platform with a textured surface offers comfortable, secure foot placement for a wide range of users

	PRODUCT DIMENSIONS (L X W X H)						PRODUCT WEIGHT		WEIGHT STACK	
	CM		INCHES				KG	LBS	KG	LBS
<b>GO-S70</b>	101	183.5	137	39.7	72.3	54	246	542.4	95	210



## LEG EXTENSION

Extra-large seat offers comfortable support for users and faster transitions in and out of the unit • Self-adjusting tibia pad provides greater ease of use • Adjustable range of motion lets users with different degrees of knee mobility build strength

	PRODUCT DIMENSIONS (L X W X H)						PRODUCT WEIGHT		WEIGHT STACK	
	CM			INCHES			KG	LBS	KG	LBS
<b>GO-S71</b>	132	130	137	52	51.3	54	178	392.5	72	160



## SEATED LEG CURL

Self-adjusting ankle pad provides greater ease of use • Adjustable range of motion lets users with different degrees of hamstring mobility build strength • Extra-large seat offers comfortable support for users and faster transitions in and out of the unit

	PRODUCT DIMENSIONS (L X W X H)						PRODUCT WEIGHT		WEIGHT STACK	
	CM			INCHES			KG	LBS	KG	LBS
<b>GO-S72</b>	128	109	137	50.5	43	54	198	436.5	54	120



### ADJUSTABLE BENCH

Five back pad adjustment angles move effortlessly to help target specific muscles and provide excellent stability during diverse exercises • An integrated exercise band attachment point accommodates elastic exercises • Space-saving vertical storage configuration • Built-in wheels and an ergonomic handle for convenient transport

	PRODUCT DIMENSIONS (L X W X H)						PRODUCT WEIGHT	
	CM	INCHES				KG	LBS	
<b>GO-AB</b>	142.4	77.5	43.7	56	30.5	17.25	36	79.5



### FUNCTIONAL TRAINER

Variable pulley ratio technology lets users train for maximum strength or focus on explosive, athletic movements • 25 height positions offers a virtually endless variety of exercises • Compact footprint helps you serve more users when space is at a premium • A low overall height makes it easy to fit into facilities with lower ceilings • Enclosed adjustment handle provides a safe and secure location to attach exercise bands for elastic training • Also available: Optional Handle Package (GO-FTHP)

	PRODUCT DIMENSIONS (L X W X H)						PRODUCT WEIGHT	
	CM	INCHES				KG	LBS	
<b>GO-FT3</b>	129.5	137.5	231	51	54	91	245.6	543.4
<b>GO-FT4</b>	129.5	137.5	231	51	54	91	292	634.4

## GO SERIES STANDARD FRAME AND UPHOLSTERY COLORS

### Iced Silver frames

Obsidian Black – Upholstery



Clay Red – Upholstery



Slate Blue – Upholstery



### Matte Black frames

Obsidian Black – Upholstery



Clay Red – Upholstery



Slate Blue – Upholstery



NOTE: All specifications are subject to change without notice. Actual products may differ from those pictured in this catalog. Actual product colors may vary from what is shown here.







# A LEGACY OF PERFORMANCE AND PROVEN DURABILITY

## MAGNUM **series**

Ideal for helping serious strength trainers reach their ultimate potential, the Magnum Series provides an unparalleled blend of performance and durability. Simple, exclusive Breaker Benches allow users to get into the start position with less stress on their joints. Other products like Double MEGA Racks pack in the functionality to help you make the most of your floor space. Best of all, everything that carries the Magnum Series name will withstand the most intense training environments.





# MAGNUM

## series

### **ERGONOMICS AND BIOMECHANICS**

Designed for comfort while providing a natural, mechanically correct motion.

### **DURABLE CONSTRUCTION**

Originally built to withstand the rigorous strength training of professional sports teams.

### **FRAME FINISH**

Automotive-quality finish is highly resistant to chips and scratches.

### **CONVERGING/DIVERGING MOTION**

Encourages a natural path of motion to enhance comfort.

### **COLOR-CODED ADJUSTMENT POINTS**

Conveniently located and clearly marked for easy use.

### **EQUIPMENT VARIETY**

A robust selection meets the training needs of virtually any facility.





## MAGNUM BREAKER BENCHES / EASIER TAKEOFFS

Incredibly beneficial for beginners and professional athletes alike, this exclusive system uses pivoting uprights to place the bar directly over the user. We call them Breaker Benches because they eliminate the need for assistance to break the bar, allowing users to get into the start position with less stress on their joints. Greater comfort, easier takeoffs and increased efficiency add up to a superior solution for all users in resistance training.

All equipment is designed to meet EN957 and ASTM safety standards.



### BREAKER OLYMPIC FLAT BENCH



Uprights pivot forward into ideal starting position, directly over the user for easy takeoff • Molded urethane guards protect Olympic bars from damage, reduce noise and provide a hand rest for spotters • Wide back pad stabilizes users during heavy lifts • 10 weight-storage horns (20-kg / 45-lb. plates store at waist height) • Designed to meet EN957 and ASTM safety standards • Shown with optional spotter platform (MG-AOSP)

	PRODUCT DIMENSIONS (L X W X H)						PRODUCT WEIGHT	
	CM		INCHES				KG	LBS
<b>MG-A678</b>	173	168	130	68	66	51	94	207

### OLYMPIC FLAT BENCH



Molded urethane guards protect Olympic bars from damage, reduce noise and provide a hand rest for spotters • Wide back pad stabilizes users during heavy lifts • 10 weight-storage horns (20-kg / 45-lb. plates store at waist height) • Designed to meet EN957 and ASTM safety standards • Shown with optional spotter platform (MG-AOSP)

	PRODUCT DIMENSIONS (L X W X H)						PRODUCT WEIGHT	
	CM		INCHES				KG	LBS
<b>MG-A78</b>	163	168	130	64	66	51	73	160

### BREAKER OLYMPIC INCLINE BENCH



Uprights pivot forward into ideal starting position, directly over the user for easy takeoff • Molded urethane guards protect Olympic bars from damage, reduce noise and provide a hand rest for spotters • Wide back pad stabilizes users during heavy lifts • Ratcheting seat design for ease of use and adjustment • 10 weight-storage horns (20-kg / 45-lb. plates store at waist height) • Comes standard with built-in spotter platform • Designed to meet EN957 and ASTM safety standards

	PRODUCT DIMENSIONS (L X W X H)						PRODUCT WEIGHT	
	CM		INCHES				KG	LBS
<b>MG-A679</b>	170	168	160	67	66	63	126	277

### OLYMPIC INCLINE BENCH



Molded urethane guards protect Olympic bars from damage, reduce noise and provide a hand rest for spotters • Wide back pad stabilizes users during heavy lifts • Ratcheting seat design for ease of use and adjustment • 10 weight-storage horns (20-kg / 45-lb. plates store at waist height) • Comes standard with built-in spotter platform • Designed to meet EN957 and ASTM safety standards

	PRODUCT DIMENSIONS (L X W X H)						PRODUCT WEIGHT	
	CM		INCHES				KG	LBS
<b>MG-A79</b>	170	168	160	67	66	63	107	235



### BREAKER OLYMPIC DECLINE BENCH

Uprights pivot forward into ideal starting position, directly over the user for easy takeoff • Molded urethane guards protect Olympic bars from damage, reduce noise and provide a hand rest for spotters • 10 weight-storage horns (20-kg / 45-lb. plates store at waist height) • Wide back pad stabilizes users during heavy lifts • Designed to meet EN957 and ASTM safety standards • Knee and ankle pads easily pivot to accommodate all user sizes

	PRODUCT DIMENSIONS (L X W X H)						PRODUCT WEIGHT	
	CM		INCHES				KG	LBS
<b>MG-A680</b>	206	168	135	81	66	53	107	235



### OLYMPIC DECLINE BENCH

Molded urethane guards protect Olympic bars from damage, reduce noise and provide a hand rest for spotters • 10 weight-storage horns (20-kg / 45-lb. plates store at waist height) • Wide back pad stabilizes users during heavy lifts • Designed to meet EN957 and ASTM safety standards • Knee and ankle pads easily pivot to accommodate all user sizes

	PRODUCT DIMENSIONS (L X W X H)						PRODUCT WEIGHT	
	CM		INCHES				KG	LBS
<b>MG-A80</b>	201	168	137	79	66	54	82	180



### BREAKER OLYMPIC SHOULDER BENCH

Uprights pivot forward into ideal starting position, directly over the user for easy takeoff • Molded urethane guards protect Olympic bars from damage, reduce noise and provide a hand rest for spotters • Comes standard with built-in spotter platform • 10 weight-storage horns (20-kg / 45-lb. plates store at waist height) • Designed to meet EN957 and ASTM safety standards

	PRODUCT DIMENSIONS (L X W X H)						PRODUCT WEIGHT	
	CM		INCHES				KG	LBS
<b>MG-A645</b>	135	138	183	53	66	72	118	260



### OLYMPIC SHOULDER BENCH

Front and rear takeoffs connected with bottom stop bar • Molded urethane guards protect Olympic bars from damage, reduce noise and provide a hand rest for spotters • Comes standard with built-in spotter platform • 10 weight-storage horns (20-kg / 45-lb. plates store at waist height) • Designed to meet EN957 and ASTM safety standards

	PRODUCT DIMENSIONS (L X W X H)						PRODUCT WEIGHT	
	CM		INCHES				KG	LBS
<b>MG-A45</b>	127	138	165	50	66	65	137	303





### 3-WAY OLYMPIC BENCH

Molded urethane guards protect Olympic bars from damage, reduce noise and provide a hand rest for spotters • Flat bench press, incline press and shoulder press can all be performed with simple adjustments • Easy-to-use seat automatically moves into proper position when back is adjusted • 10 weight-storage horns hold over 454 kg / 1000 lbs. of Olympic plates • Designed to meet EN957 and ASTM safety standards

	PRODUCT DIMENSIONS (L X W X H)						PRODUCT WEIGHT	
	CM		INCHES		KG	LBS		
<b>MG-C895</b>	186.5	165	176.5	73.5	65	69.5	179.5	396





### MULTI-ADJUSTABLE BENCH LP

Seat automatically adjusts with the back pad for ease of use • Adjustable back pad with 8 positions from 0 to 75 degrees • Tapered wide back pad stabilizes users during heavy lifts • Molded guards protect high wear / scuff areas • Transport handle and integrated wheels simplify movement within facility • Low 17.8" floor-to-pad height minimizes lower back stress and prevents arching

	PRODUCT DIMENSIONS (L X W X H)						PRODUCT WEIGHT	
	CM		INCHES				KG	LBS
<b>MG-A82</b>	152	78	46	59.7	30.6	17.8	55	121.5



### MULTI-ADJUSTABLE BENCH

Seat automatically adjusts with the back pad for ease of use • Adjustable back pad with 5 positions from 0 to 80 degrees • Wide back pad stabilizes users during heavy lifts • Molded guards protect high wear / scuff areas • Drop-away handle and integrated wheels simplify movement within facility

	PRODUCT DIMENSIONS (L X W X H)						PRODUCT WEIGHT	
	CM		INCHES				KG	LBS
<b>MG-A85</b>	135	58	51	53	23	20	43	95



### FLAT BENCH

Single cross leg provides more freedom for users • Wide back pad stabilizes users during heavy lifts • Molded guards protect high wear / scuff areas • Integrated wheels simplify movement within facility

	PRODUCT DIMENSIONS (L X W X H)						PRODUCT WEIGHT	
	CM		INCHES				KG	LBS
<b>MG-A59</b>	142	58	46	56	23	18	25	55



### MULTI-ADJUSTABLE BENCH W/DECLINE

Backrest adjusts into 7 positions — decline: -10 and 2.5 degrees; incline: 17.5, 32, 48, 64.5 and 87.5 degrees • Wide back pad stabilizes users during heavy lifts • Molded guards protect high wear / scuff areas • Leg pads provide added stability • Integrated wheels simplify movement within facility

	PRODUCT DIMENSIONS (L X W X H)						PRODUCT WEIGHT	
	CM		INCHES				KG	LBS
<b>MG-A86</b>	166	60.5	53.5	65.3	23.8	21	62	137



### UTILITY BENCH

Oversized foot supports provide maximum stability • Molded guards protect high wear / scuff areas • Oversized rubber foot platforms provide added stability • Integrated wheels simplify movement within facility

	PRODUCT DIMENSIONS (L X W X H)						PRODUCT WEIGHT	
	CM			INCHES			KG	LBS
<b>MG-A87</b>	142	66	89	56	26	35	31	68



### ADJUSTABLE DECLINE BENCH

9 adjustments from 10 to 30 degrees • Gas-assist for easy adjustment • Wide back pad stabilizes users during heavy lifts • Molded guards protect high wear / scuff areas • Integrated wheels for easy transport

	PRODUCT DIMENSIONS (L X W X H)						PRODUCT WEIGHT	
	CM			INCHES			KG	LBS
<b>MG-A61</b>	163	64	81	64	25	32	45	99



### ADJUSTABLE AB BENCH

Adjustable leg pad accommodates all users • Molded guards protect high wear / scuff areas • Back support pivots into 6 different positions from 0 to 25 degrees • Elevated knee position reduces lower-back stress

	PRODUCT DIMENSIONS (L X W X H)						PRODUCT WEIGHT	
	CM			INCHES			KG	LBS
<b>MG-A77</b>	155	69	145	61	27	57	59	131



### GLUTE HAM BENCH

Step-through design • Leg pads and oversized footplate can be adjusted while in exercise position • Gas-assisted leg pad offers easy vertical adjustment • Handles to perform reverse hyperextensions • Hooks to attach bands for reverse hyperextensions

	PRODUCT DIMENSIONS (L X W X H)						PRODUCT WEIGHT	
	CM			INCHES			KG	LBS
<b>MG-A96</b>	157	91	130	62	36	51	136	300



### STANDING ARM CURL

Arm pad height adjusts to accommodate users of all sizes • Durable extruded guards protect frame and bar • Utilizing both sides of the machine increases functionality and saves space

MG-A71	PRODUCT DIMENSIONS (L X W X H)						PRODUCT WEIGHT	
	CM			INCHES			KG	LBS
	119	79	104	47	31	41	61	135



### PREACHER CURL

Angled, ratcheting seat encourages proper body positioning • Durable extruded guards protect frame and bar

MG-A62	PRODUCT DIMENSIONS (L X W X H)						PRODUCT WEIGHT	
	CM			INCHES			KG	LBS
	119	76	99	47	30	39	57	125



### VKR W/CHIN

Oversized round handles enhance comfort on dip • Angled back support, elbow pads and handles provide added stability and comfort • Multiple chin grips and rock-climbing grips add exercise variety

MG-A63C	PRODUCT DIMENSIONS (L X W X H)						PRODUCT WEIGHT	
	CM			INCHES			KG	LBS
	135	109	245	53	43	96	120	265



### SQUAT RACK

Fixed-bottom stops provide added security • Molded urethane guards protect Olympic bars from damage and reduce noise • 5 racking positions and 8 weight-storage horns are standard • Bottom stops can also be used to hold bar for various exercises • Safety Distance from Floor 71.75 cm / 28.25"

	PRODUCT DIMENSIONS (L X W X H)						PRODUCT WEIGHT	
	CM		INCHES				KG	LBS
<b>MG-A81</b>	211.5	166.8	201	83.3	67.5	79.2	265	585



### POWER STATION

Adjustable bar stop allows positioning from 30.5" to 48" • Fixed side frame is positioned at 20° for Olympic lifts • Eight racking positions accommodate users for any type of lift • Integrated pull-up bar for increased functionality • Eight standard weight horns hold multiple weight plate sizes

	PRODUCT DIMENSIONS (L X W X H)						PRODUCT WEIGHT	
	CM		INCHES				KG	LBS
<b>MG-A73</b>	185.5	160.4	222.6	73	63.2	87.7	187.2	412.7



### PORTABLE SEAT

Provides a stable and supportive surface for resting between sets, while also helping to keep workout spaces organized and efficient • Convenient and comfortable place to sit • Compact, sturdy frame offers easy mobility

	PRODUCT DIMENSIONS (L X W X H)						PRODUCT WEIGHT	
	CM		INCHES				KG	LBS
<b>MG-A99</b>	65.5	52	50	26	20.5	20	12.5	27.6



### BACK EXTENSION BENCH

Large thigh pads and skid-resistant foot platform for enhanced stability • Handles offer easy entry and exit • Molded guards protect high wear / scuff areas

	PRODUCT DIMENSIONS (L X W X H)						PRODUCT WEIGHT	
	CM			INCHES			KG	LBS
<b>MG-A52</b>	118.6	76.3	97.3	46.7	30	38.3	53	117



### MI BACK TRAINER

Large thigh pads and skid-resistant foot platform for enhanced stability • Handles offer easy entry and exit • Hooks to attach bands for added resistance • 3 different pad adjustment angles (55, 40, 25 degrees) • Gas-assist for easy adjustment

	PRODUCT DIMENSIONS (L X W X H)						PRODUCT WEIGHT	
	CM			INCHES			KG	LBS
<b>MD-FW52</b>	135.5	73.1	100.1	53.4	28.8	39.4	58	128



### BARBELL RACK

Upright design provides convenience for barbell accessories • Rack holds 10 barbells, 5 per side • Chromed pegs provide lasting commercial finish

	PRODUCT DIMENSIONS (L X W X H)						PRODUCT WEIGHT	
	CM			INCHES			KG	LBS
<b>MG-A98</b>	138.5	88.7	152.9	54.5	34.9	60.2	81	178.6



### OLYMPIC WEIGHT TREE

9 chrome-plated storage horns for Olympic plates • Rubber bumpers on horns protect frame finish • Ergonomic design positions heavier plates further off the ground for easier removal and replacement

	PRODUCT DIMENSIONS (L X W X H)						PRODUCT WEIGHT	
	CM			INCHES			KG	LBS
<b>MG-A94</b>	87.1	57	107.9	34.3	22.5	42.5	28.8	63.5



### WEIGHT TREE W/BAR HOLDERS

6 chromed storage horns, 2 of which accommodate 20-kg / 45-lb. plates • 2 vertical bar holders for Olympic or curl bar storage • Rubber bumpers on horns protect frame finish

	PRODUCT DIMENSIONS (L X W X H)						PRODUCT WEIGHT	
	CM			INCHES			KG	LBS
<b>MG-A67B</b>	51	52	112	20	21	44	23	50



### ACCESSORY RACK

Facilitates placement of all accessories in one spot for convenience and a clutter-free facility • Top shelf holds additional accessories

	PRODUCT DIMENSIONS (L X W X H)						PRODUCT WEIGHT	
	CM			INCHES			KG	LBS
<b>MG-A97</b>	110.1	69.4	110.5	43.4	27.4	43.5	47.6	105



### STEP-UP PLATFORM W/HANDLE

20 cm / 8" step-up height • Non-slip surface

	PRODUCT DIMENSIONS (L X W X H)						PRODUCT WEIGHT	
	CM			INCHES			KG	LBS
<b>MG-SUP</b>	95	48	122.5	37.5	19	48.25	34	75



### SPOTTER PLATFORM

Wide-tapered rubber platform provides additional leverage for heavy lifting • Available as an option on the MG-A78 and MG-A678 Olympic Flat Benches • Standard on the Olympic Incline and Shoulder Press Benches

	PRODUCT DIMENSIONS (L X W X H)						PRODUCT WEIGHT	
	CM			INCHES			KG	LBS
<b>MG-A0SP</b>	66	84	29	26	33	12	28	61

### 5-PAIR PRO-STYLE DUMBBELL RACK



Storage space for 5 pairs of pro-style dumbbells up to 68 kg / 150 lbs. • 15-degree angled tray helps prevent wrist strain when removing and replacing dumbbells • Cradles hold dumbbells securely in place to prevent rolling pinch hazards • Options available: decal sheet (MG-AODS); connector plate (MG-AOCP)

	PRODUCT DIMENSIONS (L X W X H)						PRODUCT WEIGHT	
	CM		INCHES				KG	LBS
<b>MG-A505</b>	232.6	61.3	79.8	91.6	24.2	31.5	63	138.6

### 10-PAIR PRO-STYLE DUMBBELL RACK



Storage space for 10 pairs of pro-style dumbbells up to 68 kg / 150 lbs. • 15-degree angled trays help prevent wrist strain when removing and replacing dumbbells • Cradles hold dumbbells securely in place to prevent rolling pinch hazards • Options available: decal sheet (MG-AODS); connector plate (MG-AOCP)

	PRODUCT DIMENSIONS (L X W X H)						PRODUCT WEIGHT	
	CM		INCHES				KG	LBS
<b>MG-A510</b>	232.6	61.3	79.8	91.6	24.2	31.5	106	233.2

### 15-PAIR PRO-STYLE DUMBBELL RACK



Storage space for 15 pairs of pro-style dumbbells up to 68 kg / 150 lbs. • 15-degree angled trays help prevent wrist strain when removing and replacing dumbbells • Cradles hold dumbbells securely in place to prevent rolling pinch hazards • Options available: decal sheet (MG-AODS); connector plate (MG-AOCP)

	PRODUCT DIMENSIONS (L X W X H)						PRODUCT WEIGHT	
	CM		INCHES				KG	LBS
<b>MG-A515</b>	232.6	67.3	102.1	91.6	26.5	40.2	156	343.2

### 2-TIER FLAT-TRAY DUMBBELL RACK



231 cm / 91" rack holds hex head dumbbells weighing up to 52 kg / 115 lbs. • Also available: 185 cm / 73", 2-tier Flat-tray Dumbbell Rack (MG-A526) • Options available: kettlebell storage insert (MG-AO15T for top tray, MG-AO15B for bottom tray); rubber mat insert (MG-AORM6 for MG-A526 dumbbell rack, MG-AORM8 for MG-A528 dumbbell rack); decal sheet (MG-AODS); connector plate (MG-AOCP)

	PRODUCT DIMENSIONS (L X W X H)						PRODUCT WEIGHT	
	CM		INCHES				KG	LBS
<b>MG-A528</b>	232.2	62.5	79.4	91.5	24.6	31.3	127	279.4
<b>MG-A526</b>	186.2	62.5	79.4	73.3	24.6	31.3	108	237.6





### 3-TIER FLAT-TRAY DUMBBELL RACK

231 cm / 91" rack holds hex head dumbbells weighing up to 52 kg / 115 lbs. • Also available: 185 cm / 73", 3-tier Flat-tray Dumbbell Rack (MG-A536) • Options available: kettlebell storage insert (MG-AO15T for top tray, MG-AO15B for bottom tray); rubber mat insert (MG-AORM6 for MG-A536 dumbbell rack, MG-AORM8 for MG-A538 dumbbell rack); decal sheet (MG-AODS); connector plate (MG-AOCP)

	PRODUCT DIMENSIONS (L X W X H)						PRODUCT WEIGHT	
	CM		INCHES				KG	LBS
<b>MG-A538</b>	232.2	72.4	101.8	91.5	28.5	40	193	424.6
<b>MG-A536</b>	186.2	72.4	101.8	73.3	28.5	40	160	352



### STUDIO PRO-STYLE DUMBBELL RACK

Storage space for 10 pairs of pro-style dumbbells from 2-20 kg / 5-50 lbs. • 15-degree angled trays help prevent wrist strain when removing and replacing dumbbells • Space-saving design minimizes footprint and uses less space than traditional 10-pair 2-tier rack • Cradles hold dumbbells securely in place to prevent rolling pinch hazards • Options available: decal sheet (MG-AODS); connector plate (MG-AOCP)

	PRODUCT DIMENSIONS (L X W X H)						PRODUCT WEIGHT	
	CM		INCHES				KG	LBS
<b>MG-A541</b>	186.2	67.3	102.1	73.3	26.5	40.2	123	270.6



### STUDIO FLAT-TRAY DUMBBELL RACK

122 cm / 48" rack holds 2-20 kg / 5-50 lb. hex head dumbbells • Options available: kettlebell storage insert (MG-AO15T for top tray, MG-AO15B for bottom tray); rubber mat insert (MG-AORM4); decal sheet (MG-AODS); connector plate (MG-AOCP)

	PRODUCT DIMENSIONS (L X W X H)						PRODUCT WEIGHT	
	CM		INCHES				KG	LBS
<b>MG-A544</b>	123.2	72.4	101.8	48.5	28.5	39.4	118	259.6

# SMART, STABLE & INTENSELY TRANSFORMATIVE

## GLUTE TRAINER

Help athletes tone muscle, build power, and improve hip and core stability with a smarter, more stable take on high-intensity glute training. Advanced biomechanics mimic bar hip thrusting without the difficulty and discomfort of free weights, and walk-through design makes it easy for anyone to get started. Refined ergonomics accommodate users of all sizes comfortably, while high maximum resistance and elastic band hooks challenge even elite athletes.







### VERTICAL BENCH PRESS

Independent converging movement provides a natural path of motion • Back pad adjusts to alter range of motion and expand training options • Dual-grip pressing positions offer greater training variety • Ratcheting seat for easy adjustment • 4 integrated weight-storage horns

	PRODUCT DIMENSIONS (L X W X H)						PRODUCT WEIGHT	
	CM		INCHES				KG	LBS
<b>MG-PL12</b>	146.5	168.5	199.5	58.0	66.5	78.5	196	432



### SUPINE BENCH PRESS

Independent converging movement provides a natural path of motion • Dual-grip pressing positions offer greater training variety • 2 integrated weight-storage horns

	PRODUCT DIMENSIONS (L X W X H)						PRODUCT WEIGHT	
	CM		INCHES				KG	LBS
<b>MG-PL13</b>	184.5	127.5	89.5	72.5	50	35	99	218.5



### INCLINE BENCH PRESS

Independent converging movement provides a natural path of motion • Back pad adjusts to alter range of motion and expand training options • Dual-grip pressing positions offer greater training variety • Ratcheting seat for easy adjustment • 4 integrated weight-storage horns

	PRODUCT DIMENSIONS (L X W X H)						PRODUCT WEIGHT	
	CM		INCHES				KG	LBS
<b>MG-PL14</b>	208.2	143.2	129.6	82	56.5	51	147.5	325



### VERTICAL DECLINE BENCH PRESS

Independent converging movement provides a natural path of motion • Back pad adjusts to alter range of motion and expand training options • Dual-grip pressing positions offer greater training variety • Ratcheting seat for easy adjustment • 4 integrated weight-storage horns

	PRODUCT DIMENSIONS (L X W X H)						PRODUCT WEIGHT	
	CM		INCHES				KG	LBS
<b>MG-PL15</b>	148	168.5	195	58.5	66.5	77	195.5	431



### SHOULDER PRESS

Independent converging movement provides a natural path of motion • Slightly reclined position reduces lower back strain • Dual-grip pressing positions offer greater training variety • Ratcheting seat for easy adjustment • 4 integrated weight-storage horns

	PRODUCT DIMENSIONS (L X W X H)						PRODUCT WEIGHT	
	CM			INCHES			KG	LBS
<b>MG-PL23</b>	161.3	160	118.1	63.5	63	46.5	118	260



### LAT PULLDOWN

Diverging independent arms provide a natural path of motion • Easy-to-use thigh-pad adjustment for proper support • Angled seat cues optimal user position • 2 integrated weight-storage horns

	PRODUCT DIMENSIONS (L X W X H)						PRODUCT WEIGHT	
	CM			INCHES			KG	LBS
<b>MG-PL33</b>	182.9	123.2	190.5	72	48.5	75	128	282



### SEATED ROW

Diverging independent arms provide a natural path of motion • Dual-grip positions offer greater training variety • Two different foot positions accommodate a greater variety of user heights • Ratcheting seat for easy adjustment • Integrated weight-storage horn

	PRODUCT DIMENSIONS (L X W X H)						PRODUCT WEIGHT	
	CM			INCHES			KG	LBS
<b>MG-PL34</b>	152.4	139.7	106.7	60	55	42	118	260



### AB CRUNCH BENCH

Dual-supported pivot for added strength and performance • Lower step-through height for easy entry and exit • Dual-action pivot for natural biomechanics • Angled handles enhance shoulder comfort and feel • Center tube supports heavier individuals • Weight horn accommodates 12-kg / 25-lb. plates for advanced users

	PRODUCT DIMENSIONS (L X W X H)						PRODUCT WEIGHT	
	CM			INCHES			KG	LBS
<b>MG-PL50</b>	162.6	88.9	100.3	64	35	39.5	60	132.5



## SMITH MACHINE

Counterbalanced 11.3-kg / 25-lb. bar takeoff for low starting resistance • Features a 90-degree path of motion adapts to all exercises • Linear bearings provide a smooth motion • Non-removable safety stops add training security • 8 integrated weight-storage horns hold multiple weight-plate sizes

	PRODUCT DIMENSIONS (L X W X H)				PRODUCT WEIGHT			
	CM	INCHES	KG	LBS	KG	LBS		
<b>MG-PL62</b>	110.5	231.1	245.1	43.5	91	96.5	270	569



### 45° LEG PRESS

Easy-to-use and see racking mechanism • Adjustable bottom stops provide long or short ranges of motion for all user heights • Adjustable angle back pad enhances comfort, optimizes hip angles and accommodates a greater range of users • Assistance handle on platform for easier entry and exit • Linear bearings for smooth feel and function • 4 integrated weight-storage horns hold multiple weight-plate sizes

	PRODUCT DIMENSIONS (L X W X H)						PRODUCT WEIGHT	
	CM		INCHES				KG	LBS
<b>MG-PL70</b>	229	171	158	90	67.5	62.3	274	604



### GLUTE TRAINER

Comfortable user positioning and efficient machine layout mimic bar hip thrusting without the hassle of unwieldy free weights • Walk-through design with swiveling hip pad provides easy entry and exit • Maximum resistance of 227 kg / 500 lbs. • Integrated dual-sided band hooks provide elastic resistance for explosiveness training and movement variety • Floating hip pad adjusts to fit users of all sizes and comfortable feel • Large, angled foot platform with non-slip surface offers excellent stability to better engage glutes • Oversized shoulder pad provides comfortable torso support

	PRODUCT DIMENSIONS (L X W X H)						PRODUCT WEIGHT	
	CM		INCHES				KG	LBS
<b>MG-PL78</b>	168	133	109	66.5	52.5	43	154	340



### HACK SQUAT

Large footplate and back pad accommodate users of all sizes • Spring-loaded take off handles for ease of use and engagement • Adjustable bottom stops provide long or short ranges of motion for all user heights • 4 integrated weight-storage horns

	PRODUCT DIMENSIONS (L X W X H)						PRODUCT WEIGHT	
	CM		INCHES				KG	LBS
<b>MG-PL71</b>	228.2	150	144.6	90	59	57	270	595



### SQUAT / LUNGE

Independent lifting arms for balanced exercise and exercise variation • Multiple hand-grip positions offer greater training variety • 3 integrated weight-storage horns keep weight plates in close proximity • 4 user weight horns provide maximal loading for strong users

	PRODUCT DIMENSIONS (L X W X H)						PRODUCT WEIGHT	
	CM		INCHES				KG	LBS
<b>MG-PL79</b>	148.6	170.2	86.4	58.5	67	34	120	264.5



### STANDING CALF

Adjustable height shoulder pads accommodate users of all sizes • Angled footplate provides superior grip and improves calf recruitment • Angled support handles enhance comfort

	PRODUCT DIMENSIONS (L X W X H)						PRODUCT WEIGHT	
	CM		INCHES				KG	LBS
<b>MG-PL76</b>	138	89	184.5	54.5	35	73	124	273.5



### REVERSE BACK EXTENSION

Adjustable starting point to select desired range of motion • Leg pad can be locked in forward position to use without resistance • Dual hand grips provide added variety and comfort • 2 weight-storage horns

	PRODUCT DIMENSIONS (L X W X H)						PRODUCT WEIGHT	
	CM		INCHES				KG	LBS
<b>MG-405</b>	150	109	145	59	43	57	134	295



### SEATED CALF

Seat moves with input arm to maintain alignment • Curved and angled foot pad improves comfort and calf recruitment • Quick-release bar catch simplifies operation • Knee pads adjust for tibia length and range of motion

	PRODUCT DIMENSIONS (L X W X H)						PRODUCT WEIGHT	
	CM		INCHES				KG	LBS
<b>MG-PL77</b>	141	80	96.5	55.5	31.5	38	65	143.5





## DOUBLE MEGA RACK CONFIGURATION

It doesn't get any bigger than this. Matrix Double MEGA Racks take your training to the max. A combination of two racks and custom connecting elements, the Double MEGA Rack allows you to tailor your equipment to your facility. This flexibility enables you to define your own priorities and get the most out of your investment each and every training day. Plus, the Matrix 7-gauge steel uprights and heavy-duty frames mean the Double MEGA Rack can simultaneously handle your toughest athletes and your most rigorous workouts. Maximize your space and your athletes at the same time with the Double MEGA Rack.

*\* Shown with optional accessories.*







## MEGA POWER RACK

Fully enclosed style offers ideal spotting abilities • Shown with adjustable safety bars, dual-grip chin bar, bar storage, band storage and weight storage • J-hooks made of high-density polyethylene (HDPE) to protect Olympic bars from scratches • Visual height indicator and colored locking pin make bar-level changes quick and easy • 3 retractable lower-band pegs on each side (6 total)

	PRODUCT DIMENSIONS (L X W X H)						PRODUCT WEIGHT	
	CM		INCHES				KG	LBS
<b>MG-MR47</b>	206	207	246.5	81	81.5	97	347	765



## MEGA HALF RACK

Open-front design gives users freedom of movement • Shown with adjustable safety bars, dual-grip chin bar, bar storage, band storage and weight storage • J-hooks made of high-density polyethylene (HDPE) to protect Olympic bars from scratches • Visual height indicator and colored locking pin make bar-level changes quick and easy • 3 retractable lower-band pegs on each side (6 total)

	PRODUCT DIMENSIONS (L X W X H)						PRODUCT WEIGHT	
	CM		INCHES				KG	LBS
<b>MG-MR690</b>	170.5	207	246.5	67	81.5	97	259	570



# MAGNUM VRS PLATFORM

Reduce sound, vibration and bounce while protecting your equipment with our Vibration Reduction System (VRS).

Create an unmatched strength training environment with platforms featuring our exclusive Vibration Reduction System. Our impact-absorption platforms reduce sound and bounce caused by dropping barbells during Olympic lifts, protecting floors, bars, weights, and plates from hard use. The multi-layer design minimizes vibrations transferred through floors, essential for above-ground training facilities. VRS Platform kits are available in a variety of styles and sizes, so it's easy to upgrade existing Matrix platforms or create a rugged new training experience featuring our Vibration Reduction System.



	PRODUCT DIMENSIONS (L X W X H)				PRODUCT WEIGHT			
	CM		INCHES		KG	LBS		
<b>MA4794P-VRS</b>	366	254	7	144	100	2.6	227	500.5
<b>MA4794P-VRS-4</b>	305	254	7	120	100	2.6	174	383.5
<b>MA9091P-VRS</b>	330	254	7	130	100	2.6	218	480.5
<b>MA9091P-VRS-4</b>	270	254	7	106	100	2.6	165	363.5
<b>PS86-VRS</b>	191	254	7	75	100	2.6	184	406
<b>PS84-VRS</b>	131	254	7	51.5	100	2.6	131	289
<b>VRS-KIT</b>	181.5	68	11.5	71.5	26.8	4.5	71	156
<b>VRS-KIT-4</b>	121	68	11.5	48	26.8	4.5	47.5	104



### MEGA PLATFORM W/ HARDWOOD INSERT

Durable rubber training surface to absorb impact, dampen noise and protect flooring during Olympic lifts • Hardwood center insert provides optimum foot grip and stability during explosive Olympic lifts • MA4794P for use with the MR47, A94 • MA90191P for use with MR690, A690, MR691, A691 • Available training area length options: 131 cm / 4' (MA4794P-4, MA9091P-4) and 191 cm / 6' (MA4794P, MA9091P)

	PRODUCT DIMENSIONS (L X W X H)						PRODUCT WEIGHT	
	CM			INCHES			KG	LBS
<b>MA4794P-4</b>	305	254	7	120	100	2.6	195.5	431
<b>MA9091P-4</b>	270	254	7	106	100	2.6	186.5	411
<b>MA4794P</b>	363	254	7	143	100	2.6	259.5	572
<b>MA9091P</b>	328	254	7	129	100	2.6	250.5	552

### MEGA SOLID RUBBER SURFACE PLATFORM

Durable rubber training surface to absorb impact, dampen noise and protect flooring during Olympic lifts • Options available: MEGA Solid Rubber Surface Platform • MARP4794 for use with MR47, A694 • MARP9091 for use with MR690, • Available training area length options: 131 cm / 4' (MARP4794-4, MARP9091-4) and 191 cm / 6' (MARP4794, MARP9091)

	PRODUCT DIMENSIONS (L X W X H)						PRODUCT WEIGHT	
	CM			INCHES			KG	LBS
<b>MARP4794-4</b>	305	254	7	120	100	2.6	215.5	475
<b>MARP9091-4</b>	270	254	7	106	100	2.6	203	448
<b>MARP4794</b>	366	254	7	144	100	2.6	292.5	645
<b>MARP9091</b>	330	254	7	130	100	2.6	280	617



### STAND-ALONE RUBBER PLATFORM W/HARDWOOD INSERT

Durable rubber training surface to absorb impact, dampen noise and protect flooring during explosive Olympic lifts • Hardwood center insert provides optimum foot grip and stability during explosive Olympic lifts • Available training area length options: 131 cm / 4' (PS84) and 191 cm / 6' (PS86)

	PRODUCT DIMENSIONS (L X W X H)						PRODUCT WEIGHT	
	CM		INCHES				KG	LBS
<b>PS84</b>	131	254	7	51.5	100	2.6	153	337
<b>PS86</b>	191	253	7	75	100	2.6	216.5	477

### STAND-ALONE SOLID RUBBER PLATFORM

Durable rubber training surface to absorb impact, dampen noise and protect flooring during Olympic lifts • Available training area length options: 131 cm / 4' (RP84) and 191 cm / 6' (RP86)

	PRODUCT DIMENSIONS (L X W X H)						PRODUCT WEIGHT	
	CM		INCHES				KG	LBS
<b>RP84</b>	131	254	7	51.5	100	2.6	156	344
<b>RP86</b>	191	253	7	75	100	2.6	233	514





### REVERSE J-HOOKS

Made of high-density polyethylene (HDPE) to protect bar knurling • For use on the outside of the MR47 Mega Power Rack • Available in Ridge Black only

	PRODUCT DIMENSIONS (L X W X H)						PRODUCT WEIGHT	
	CM			INCHES			KG	LBS
<b>OPT1R</b>	36	13	25	14	5	10	14	30

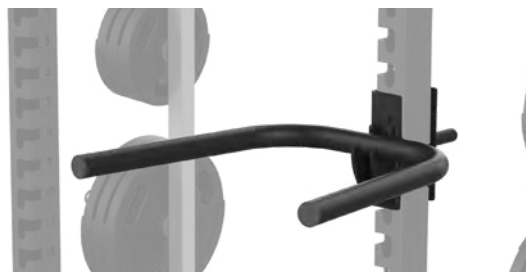

### DIP BARS

Attaches to rack uprights for body-weight dips • For use on the MR690 Mega Half Rack • Also available: Reverse Dip Bars (OPT3R) for use on the MR47 Mega Power Rack • Available in Ridge Black only

	PRODUCT DIMENSIONS (L X W X H)						PRODUCT WEIGHT	
	CM			INCHES			KG	LBS
<b>OPT3</b>	86	69	26	34	27	10	16	35



### PLATFORM RAMP

Ramp allows for gradual incline to rack platforms • Replaces standard platform framework • Available in Ridge Black only

	PRODUCT DIMENSIONS (L X W X H)						PRODUCT WEIGHT	
	CM			INCHES			KG	LBS
<b>OPT11</b>	14.5	107	6.5	5.7	42	2.5	6	13.2



### MEGA LAND MINE ATTACHMENT

Attaches to any rack for rotational training (bar not included) • Available in Ridge Black only

	PRODUCT DIMENSIONS (L X W X H)						PRODUCT WEIGHT	
	CM			INCHES			KG	LBS
<b>MOPT13</b>	67	21	19.5	26.3	8.3	7.7	9.5	21



### CORE HANDLE

Used with an Olympic bar and Land Mine Attachment for added training variety • Available in Ridge Black only

	PRODUCT DIMENSIONS (L X W X H)						PRODUCT WEIGHT	
	CM			INCHES			KG	LBS
<b>OPT16</b>	48	79	5	19	31	2	5	10

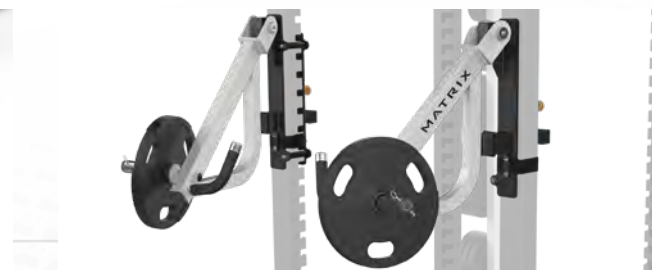

### JAMMIN ARMS

Angled pressing arms can be placed at 13 different heights for added training variety • For use on the MR690 Mega Half Rack • Also available: Reverse Jammin Arms (OPT17R) for use on the outside of the MR47 Mega Power Rack

	PRODUCT DIMENSIONS (L X W X H)						PRODUCT WEIGHT	
	CM			INCHES			KG	LBS
<b>OPT17</b>	94	53	94	37	21	37	49	108



## JAMMIN ARMS W/ BAND ATTACHMENT

Angled pressing arms with band attachments for added training variety with speed and resistance • For use on the MR690 Mega Half Rack • Also available: Reverse Jammin Arms w/ Band Attachment • (OPT17RB) for use on the MR47 Mega Power Rack

	PRODUCT DIMENSIONS (L X W X H)						PRODUCT WEIGHT	
	CM		INCHES				KG	LBS
<b>OPT17B</b>	107	56	97	42	22	38	52	114



## MEGA RACK BATTLE ROPE ATTACHMENT

For rope training as an anchor point on any rack • Available in Chrome finish only

	PRODUCT DIMENSIONS (L X W X H)						PRODUCT WEIGHT	
	CM		INCHES				KG	LBS
<b>MOPT31</b>	18	23	17	7	9	7	4	7



## STRAIGHT LADDER

Horizontal ladder connecting power racks together for bodyweight training • For use on the MR47 Mega Power Rack • Also available: Straight Ladder Connecting Bracket in both 244 cm / 8' (OPT32-8) and 297 cm / 9'9" (OPT32-10) lengths • Available in Matte Black only

	PRODUCT DIMENSIONS (L X W X H)						PRODUCT WEIGHT	
	CM		INCHES				KG	LBS
<b>OPT32-8</b>	243.9	81.2	7.7	96	32	3	42.5	93.6
<b>OPT32-10</b>	297.2	81.2	7.7	117	32	3	51.5	113.2



## PYRAMID LADDER

Elevated ladder connecting power racks together for bodyweight training • For use on the MR47 Mega Power Rack • Also available: Pyramid Ladder Connecting Bracket in 244 cm / 8' (OPT33-8) and 297 cm / 9'9" (OPT33-10) lengths • Available in Matte Black only

	PRODUCT DIMENSIONS (L X W X H)						PRODUCT WEIGHT	
	CM		INCHES				KG	LBS
<b>OPT33-8</b>	243.9	68.6	51.5	96	27	20.3	44.5	98
<b>OPT33-10</b>	297.2	68.6	53.1	117	27	20.9	53.3	117.2



## MEGA DUAL OLYMPIC BAR STORAGE

Vertical Olympic bar storage

	PRODUCT DIMENSIONS (L X W X H)						PRODUCT WEIGHT	
	CM		INCHES				KG	LBS
<b>MOPT41</b>	18	110	33	7	43	13	21.8	48



## MEGA ROTATING CHIN HANDLES

Handles rotate into multiple positions for added exercise variety • For use on the MR47 Mega Power Rack • Available in Ridge Black only

	PRODUCT DIMENSIONS (L X W X H)						PRODUCT WEIGHT	
	CM		INCHES				KG	LBS
<b>MOPT42</b>	16.1	109.2	46.4	6.4	43	18.3	15	33



### MEGA SIDE-MOUNTED PULL-UP BAR

Mounts upward or downward for bodyweight exercises or additional suspension-device exercises • For use on the MR47 Mega Power Rack • Available in Ridge Black only

	PRODUCT DIMENSIONS (L X W X H)						PRODUCT WEIGHT	
	CM		INCHES				KG	LBS
<b>MOPT43</b>	131	28	17	51.6	11	6.7	9	20

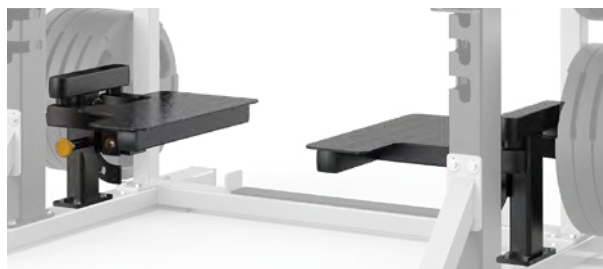

### BOLT-ON SPOTTER STANDS

Two bolt-on spotter stands • Attaches to any rack • Available in Ridge Black only

	PRODUCT DIMENSIONS (L X W X H)						PRODUCT WEIGHT	
	CM		INCHES				KG	LBS
<b>OPT45</b>	38	81.5	29.5	15	32	11.5	31	68



### BOLT-ON FRONT BAND PEG

Two bolt-on upper band pegs for added training variety • For use on the MR47 Mega Power Rack • Available in Ridge Black only

	PRODUCT DIMENSIONS (L X W X H)						PRODUCT WEIGHT	
	CM		INCHES				KG	LBS
<b>OPT46</b>	28	16	27	11	6.25	10.5	4	9



### HORIZONTAL PLATE RACK

Can hold a maximum of 314 kg / 693 lbs. in various weight plate configurations • Includes 1 horn to hold collars, and 1 Olympic bar storage horn • Integrated wheels for easy transport • Available in Ridge Black only

	PRODUCT DIMENSIONS (L X W X H)						PRODUCT WEIGHT	
	CM		INCHES				KG	LBS
<b>MG-A301</b>	160	38.1	43.2	63	15	17	25	55



### FLAT-TO-INCLINE BENCH W/HORIZONTAL ADJUSTMENT

Locking rods for attachment to power racks • Lever allows user to adjust horizontal length of bench while seated • Seat automatically adjusts to proper angle as the backrest is adjusted • Drop-away handle and wheels provide easy movement • \*Optional docking kit required to secure bench to racks

	PRODUCT DIMENSIONS (L X W X H)						PRODUCT WEIGHT	
	CM		INCHES				KG	LBS
<b>MG-A695</b>	137	76	51	54	30	20	64	140

## MAGNUM STANDARD FRAME AND UPHOLSTERY COLORS

### Iced Silver frames

Obsidian Black – Upholstery



Clay Red – Upholstery



Slate Blue – Upholstery



### Matte Black frames

Obsidian Black – Upholstery



Clay Red – Upholstery



Slate Blue – Upholstery



NOTE: All specifications are subject to change without notice. Actual products may differ from those pictured in this catalog. Actual product colors may vary from what is shown here.



# DESIGNED FOR SUPERIOR VALUE AND TRAINING VARIETY

## VARSIITY series

The Varsity Series is the ideal choice for heavy-use facilities looking for a combination of performance and value. Smart design helps you make efficient use of your space and your budget, like our versatile functional trainers and plate-loaded equipment that provide conveniently contained personal training areas. If you're looking to accommodate a steady stream of users in a limited space, look no further than the Varsity Series.



# VARSlTY

**series**

## **DURABLE CONSTRUCTION**

Originally built to withstand the rigorous strength training of professional sports teams.

## **COLOR-CODED ADJUSTMENT POINTS**

Conveniently located and clearly marked for easy use.

## **VALUE**

Designed to handle a steady stream of users for years to come.





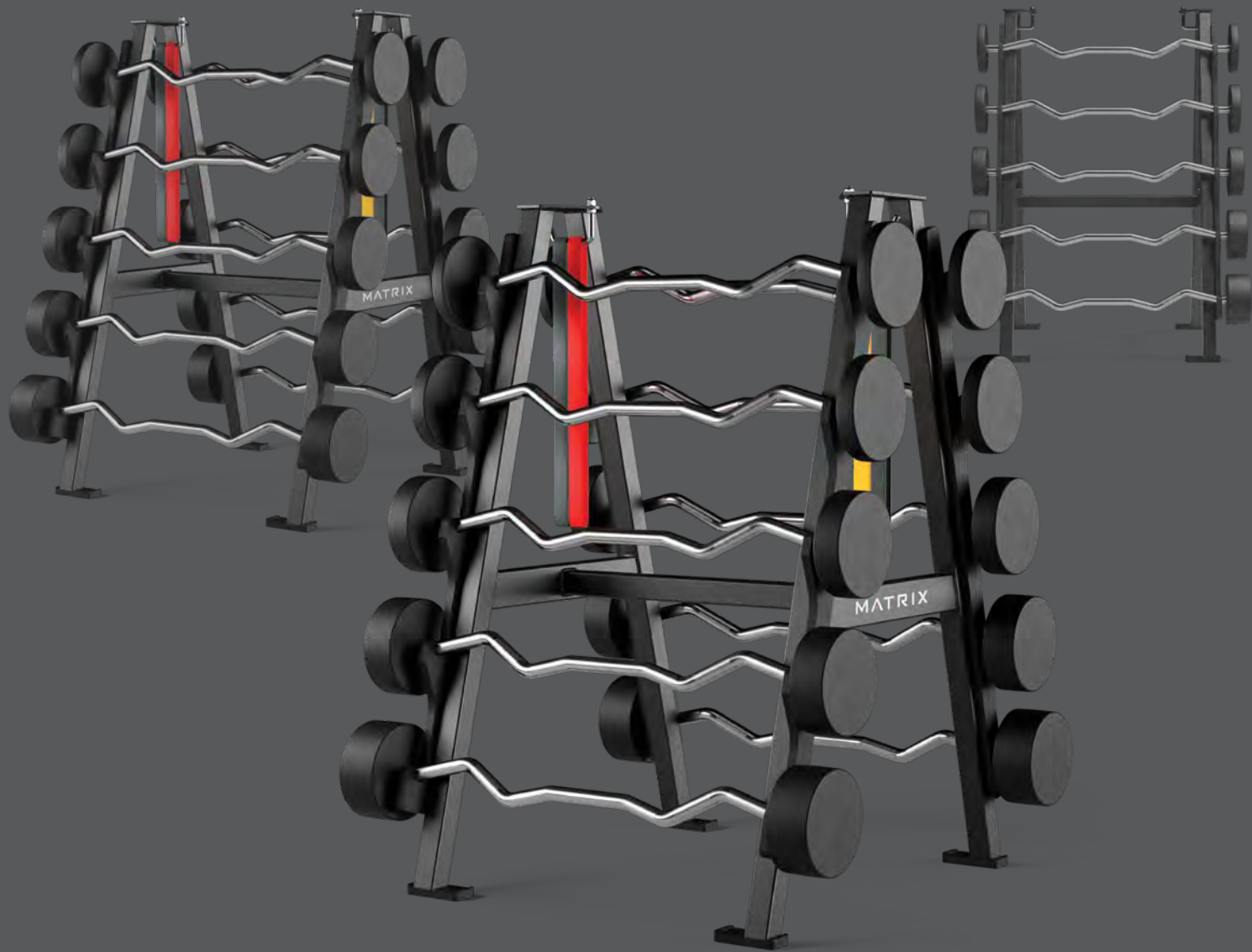



### ANGLED SMITH MACHINE

Olympic bar is counterbalanced to 11.8 kg / 26 lbs. • Olympic bar is mounted on linear bearings and shaft at a 7-degree angle • Open-ended frame design provides easy access • Flip in and out adjustable stops • 12 integrated weight-storage horns

	PRODUCT DIMENSIONS (L X W X H)						PRODUCT WEIGHT	
	CM			INCHES			KG	LBS
<b>VY-M49</b>	107	218	211	42	86	83	186	410



### PERFECT SQUAT

Large, angled, heavy-duty footplate adds stability • Adjustable starting position allows user to set pad height for squats or standing calf raises • Shoulder pads maintain parallel position to floor throughout full range of motion • 2 integrated weight-storage horns • Ideal for squats, calf work and reverse lunges

	PRODUCT DIMENSIONS (L X W X H)						PRODUCT WEIGHT	
	CM			INCHES			KG	LBS
<b>VY-400</b>	157	84	168	62	33	66	147	325



### LEG EXTENSION

Self-adjusting tibia pad enhances comfort • Back pad is adjustable from the seated position for proper alignment • 2 integrated weight-storage horns

	PRODUCT DIMENSIONS (L X W X H)						PRODUCT WEIGHT	
	CM		INCHES				KG	LBS
VY-401	102	157	117	40	62	46	91	200



### PRONE LEG CURL

Divergent angle of lower-leg pad eliminates lower-back stress • Neutral position handgrips enhance comfort and stability

	PRODUCT DIMENSIONS (L X W X H)						PRODUCT WEIGHT	
	CM		INCHES				KG	LBS
VY-402	173	91	72	68	36	30	91	200



### BICEPS CURL

Side arm pads encourage proper user positioning • 1 integrated weight-storage horn • Counterbalanced exercise arm offers optimal resistance

	PRODUCT DIMENSIONS (L X W X H)						PRODUCT WEIGHT	
	CM			INCHES			KG	LBS
VY-431	97	107	112	38	42	44	68	150



### TRICEPS EXTENSION

Adjustable knee pads help stabilize user during exercise • Side arm pads encourage proper positioning • 1 integrated weight-storage horn • Counterbalanced exercise arm offers optimal resistance

	PRODUCT DIMENSIONS (L X W X H)						PRODUCT WEIGHT	
	CM			INCHES			KG	LBS
VY-432	97	107	140	38	42	55	68	150

## VARSITY STANDARD FRAME AND UPHOLSTERY COLORS

### Iced Silver frames

Obsidian Black – Upholstery

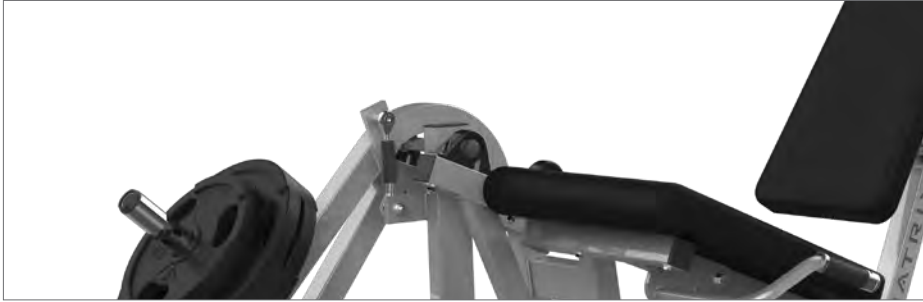

Clay Red – Upholstery

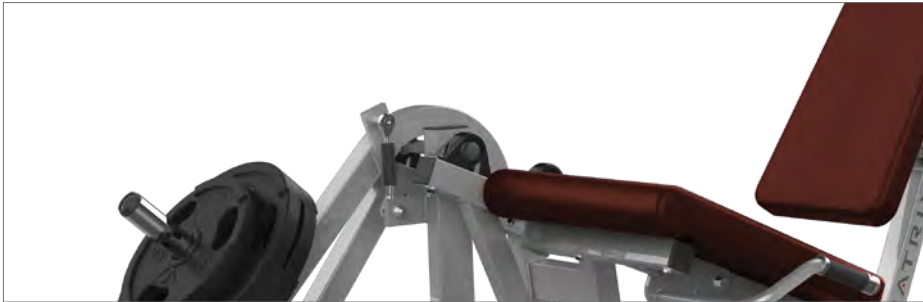

Slate Blue – Upholstery



### Matte Black frames

Obsidian Black – Upholstery



Clay Red – Upholstery



Slate Blue – Upholstery



NOTE: All specifications are subject to change without notice. Actual products may differ from those pictured in this catalog. Actual product colors may vary from what is shown here.

# DIVERSITY AND DURABILITY TO GET THE JOB DONE

## G1 series

The Varsity Series is the ideal choice for heavy-use facilities looking for a combination of performance and value. Smart design helps you make efficient use of your space and your budget, like our versatile functional trainers and plate-loaded equipment that provide conveniently contained personal training areas. If you're looking to accommodate a steady stream of users in a limited space, look no further than the Varsity Series.



# G1 series

## **DURABLE CONSTRUCTION**

Built to withstand the rigorous strength training of professional sports teams.

## **ERGONOMIC DESIGN**

Designed to fit the body for comfortable, natural use.

## **WEIGHT-STORAGE HORNS**

Conveniently positioned and designed to accommodate a variety of plate sizes.

## **EASY ACCESS**

Designed for quick on/off, ideal for busy training environments.

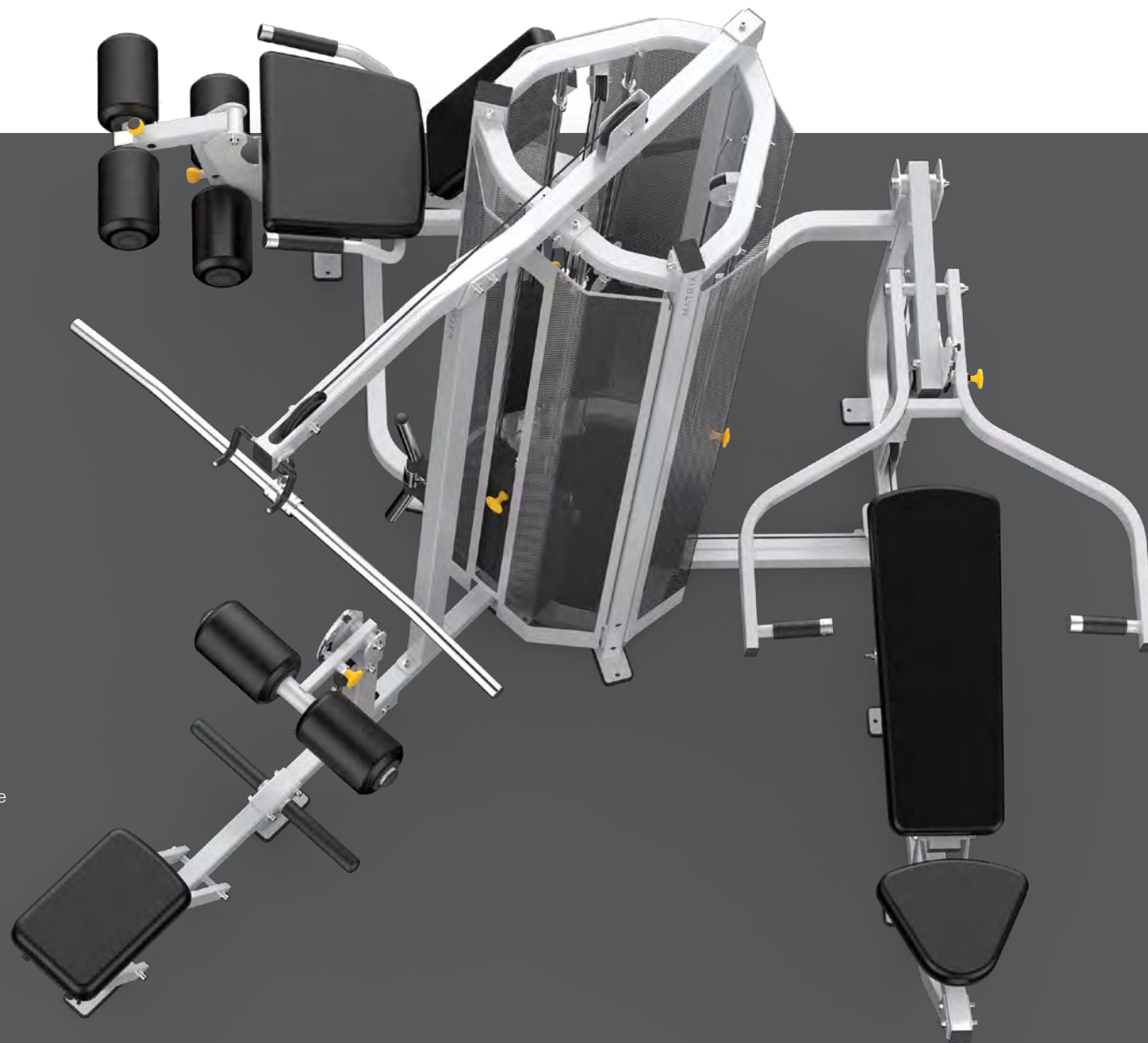





MATRIX

G1 SERIES



## ADJUSTABLE CABLE CROSSOVER

Adjustable pulley provides 17 positions • Each weight stack provides a 1:2 resistance ratio • Integrated pull-up bar provides both lat bar and neutral grips • Front weight-stack shields meet EN requirements

	PRODUCT DIMENSIONS (L X W X H)						PRODUCT WEIGHT		WEIGHT STACK	
	CM		INCHES				KG	LBS	KG	LBS
<b>G1-MS20</b>	377	110	230	148	43	91	395	870	2 X 91	2 X 200



### 3-STACK MULTI-GYM

Three weight stacks allow multiple users to exercise simultaneously • Stations include: multiple position chest / shoulder press, lat pulldown / low row, leg extension / prone leg curl

	PRODUCT DIMENSIONS (L X W X H)						PRODUCT WEIGHT		WEIGHT STACK	
	CM			INCHES			KG	LBS	KG	LBS
<b>G1-MG30</b>	282	323	218	111	127	86	592	1305	3 X 91	3 X 200



### 4-STACK MULTI-STATION

Four weight stacks allow multiple users to exercise simultaneously • Weight stack shields meet EN requirements • Stations include lat pulldown, low row and triceps pulldown • Conveniently located adjustment points are clearly marked for ease of use • 8-stack multi-station includes additional lat pulldown, low row and triceps pulldown plus connecting tube for a complete cable crossover

	PRODUCT DIMENSIONS (L X W X H)						PRODUCT WEIGHT		WEIGHT STACK	
	CM			INCHES			KG	LBS	KG	LBS
<b>G1-MS40</b>	387	180	230	152	71	91	645	1420	4 X 91	4 X 200

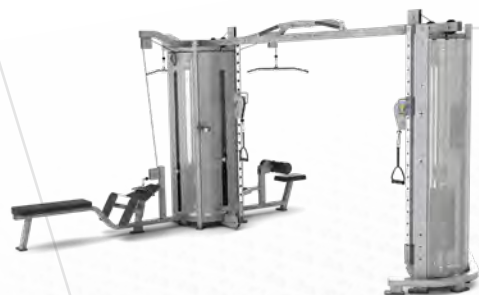

### 5-STACK MULTI-STATION

Includes all of the features listed with the 4-stack multi-station • Additional adjustable cable column and connecting tube for a complete cable crossover

	PRODUCT DIMENSIONS (L X W X H)						PRODUCT WEIGHT		WEIGHT STACK	
	CM			INCHES			KG	LBS	KG	LBS
<b>G1-MS50</b>	482	386	230	190	152	91	857	1889	5 X 91	5 X 200



### 8-STACK MULTI-STATION

Includes all of the features listed with the 4-stack multi-station • 8-stack multi-station includes additional lat pulldown, low row and triceps pulldown plus connecting tube for a complete cable crossover

	PRODUCT DIMENSIONS (L X W X H)						PRODUCT WEIGHT		WEIGHT STACK	
	CM			INCHES			KG	LBS	KG	LBS
<b>G1-MG80</b>	586	479	230	230	189	91	1319	2907	8 X 91	8 X 200



### FLAT BENCH

3-point foot contact for stability • Bench anchors for improved stability

	PRODUCT DIMENSIONS (L X W X H)						PRODUCT WEIGHT	
	CM	INCHES				KG	LBS	
<b>G1-FW151</b>	155	56	46	61	22	18	35	77



### ADJUSTABLE DECLINE BENCH

Back pad easily adjusts to 4 positions from 0 to 30-degree decline • Legs are supported and knees elevated to reduce lower-back strain • Integrated wheels for easy transport within facility

	PRODUCT DIMENSIONS (L X W X H)						PRODUCT WEIGHT	
	CM	INCHES				KG	LBS	
<b>G1-FW152</b>	208	63	97	82.0	25	38	50	110



### UTILITY BENCH

Back angle is at 85 degrees, improving comfort and stability for overhead movements • Integrated foot supports enhance stability

	PRODUCT DIMENSIONS (L X W X H)						PRODUCT WEIGHT	
	CM	INCHES				KG	LBS	
<b>G1-FW156</b>	114	56	102	45.0	22	40	22	48



### PREACHER CURL BENCH

Elbow pad is angled at 55 degrees for varying resistance and improved user comfort • Ratcheting seat pad is angled at 10 degrees for enhanced stability and comfort

	PRODUCT DIMENSIONS (L X W X H)						PRODUCT WEIGHT	
	CM		INCHES				KG	LBS
<b>G1-FW155</b>	119	72	95	47	28	37	37	82



### BACK EXTENSION

Bench is angled at 45 degrees for easy entry and exit • Twist-locking pull pin improves stability of pads

	PRODUCT DIMENSIONS (L X W X H)						PRODUCT WEIGHT	
	CM		INCHES				KG	LBS
<b>G1-FW162</b>	127	74	86	50	29	34	45	99



### OLYMPIC FLAT BENCH

Easy spotter access • Integrated weight-storage horns keep plates in close proximity • Footrest enhances user stability

	PRODUCT DIMENSIONS (L X W X H)						PRODUCT WEIGHT	
	CM		INCHES				KG	LBS
<b>G1-FW163</b>	176	201	127	70	79.0	50	65	144



### OLYMPIC INCLINE BENCH

Bench is angled at 30 degrees to emphasize upper pectoral activation • Adjustable ratcheting seat accommodates a variety of users

	PRODUCT DIMENSIONS (L X W X H)						PRODUCT WEIGHT	
	CM		INCHES				KG	LBS
<b>G1-FW164</b>	178	155	137	70	61	54	68	150



### OLYMPIC DECLINE BENCH

Bench is angled at -15 degrees for effective pectoral activation • Adjustable knee support accommodates a variety of users • 3 takeoff positions provide adaptability for users with varying arm lengths

	PRODUCT DIMENSIONS (L X W X H)						PRODUCT WEIGHT	
	CM		INCHES				KG	LBS
<b>G1-FW165</b>	178	218	132	70	86	52	80	176

Weight plates and Olympic bar are not included.



### SMITH MACHINE

Bar travel limited to 72 cm / 28.5" from the floor • 6 integrated weight-storage horns • Adjustable stops flip in and out for easy access

	PRODUCT DIMENSIONS (L X W X H)						PRODUCT WEIGHT	
	CM		INCHES				KG	LBS
<b>G1-FW161</b>	205	141	229	80.5	55.5	90	135	297

Weight plates are not included.



### WEIGHT TREE

6 weight-storage horns positioned to fit all sizes of Olympic plates • Rubber bumpers protect frame finish

	PRODUCT DIMENSIONS (L X W X H)							PRODUCT WEIGHT	
	CM			INCHES				KG	LBS
<b>G1-FW157</b>	67	54	127	26	21	50	15	33	

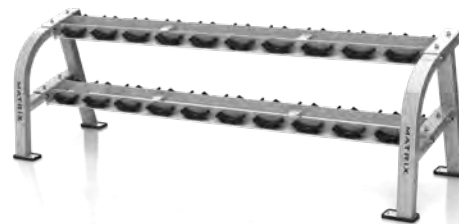

### 10-PAIR DUMBBELL RACK

Offset angle prevents wrist strain when removing and replacing dumbbells • Individual dumbbell cradles provide secure storage • Storage space for 10 pairs of dumbbells

	PRODUCT DIMENSIONS (L X W X H)						PRODUCT WEIGHT	
	CM		INCHES		KG	LBS		
<b>G1-FW159</b>	244	66	72.5	96	26	28.5	100	220



### BARBELL RACK

Upright design provides easy access to barbells • Rack holds 10 barbells, 5 per side

	PRODUCT DIMENSIONS (L X W X H)							PRODUCT WEIGHT	
	CM			INCHES				KG	LBS
<b>G1-FW160</b>	99	84	150	39	33	59	55	121	



### 5-PAIR DUMBBELL RACK

Storage space for 5 pairs of dumbbells • Offset angle prevents wrist strain when removing and replacing dumbbells • Individual dumbbell cradles provide secure storage

	PRODUCT DIMENSIONS (L X W X H)						PRODUCT WEIGHT	
	CM		INCHES		KG	LBS		
<b>G1-FW158</b>	244	66	72.5	96	26	28.5	63	139

## G1 STANDARD FRAME AND UPHOLSTERY COLORS

### Iced Silver frames

Obsidian Black – Upholstery



Clay Red – Upholstery



Slate Blue – Upholstery



### Matte Black frames

Obsidian Black – Upholstery



Clay Red – Upholstery



Slate Blue – Upholstery



NOTE: All specifications are subject to change without notice. Actual products may differ from those pictured in this catalog. Actual product colors may vary from what is shown here.





# VRS Weight Stack Kits

Create a more enjoyable training environment by adding our exclusive Vibration Reduction System to your Matrix strength equipment.

- Reduces sound from dropped weight stacks by up to 43 percent
- Reduces transferred vibration by up to 50 percent for spaces above, below or adjacent to training environments
- Reduces wear and tear caused by rebounding weight stacks
- Specifically designed to fit and maximize the performance of Ultra, Versa, Aura and Go Series single- and multi-station units

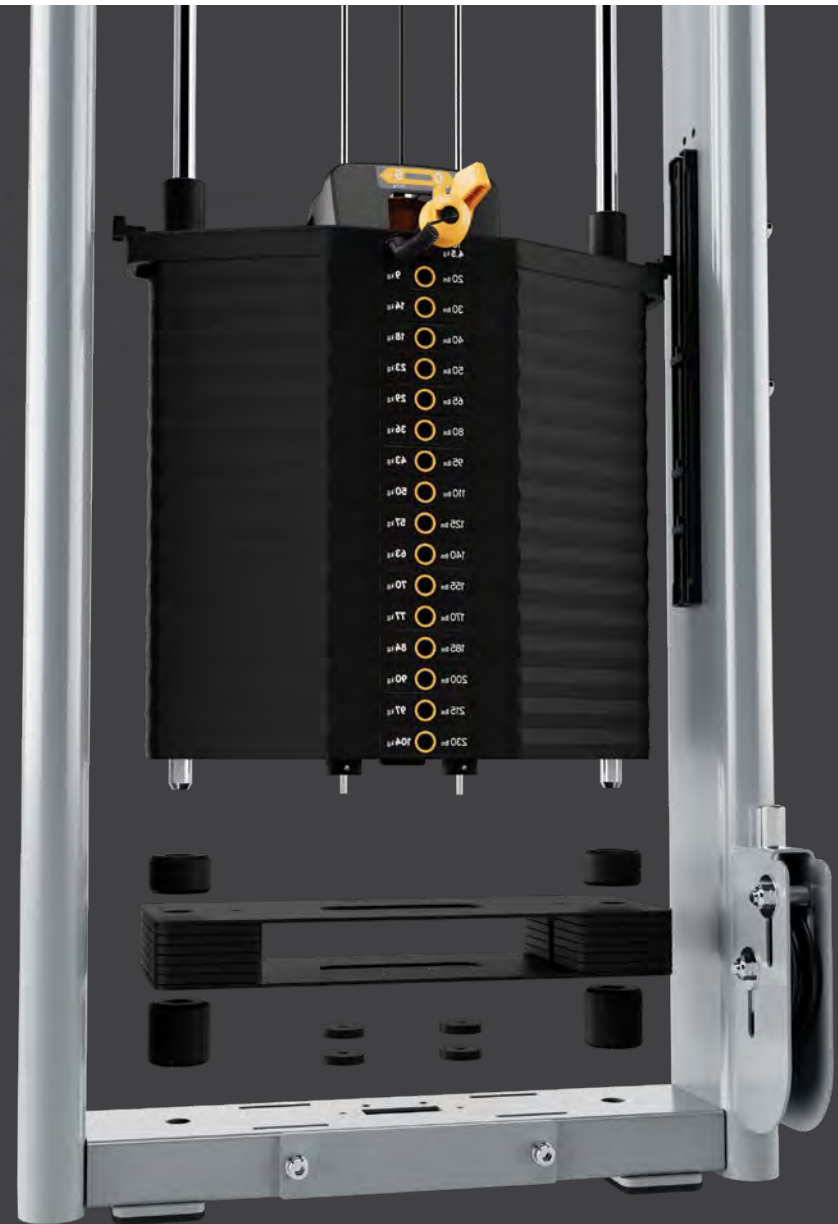



20 lbs	9 kg
30 lbs	14 kg
40 lbs	18 kg
50 lbs	23 kg
60 lbs	27 kg
70 lbs	32 kg
80 lbs	36 kg
90 lbs	41 kg
100 lbs	45 kg
110 lbs	50 kg
120 lbs	54 kg
130 lbs	59 kg
140 lbs	64 kg
150 lbs	68 kg

**WARNING**  
Read and understand the instructions before using this equipment.  
Do not use this equipment if you are pregnant, have a heart condition, or are recovering from surgery.  
Always use proper form and technique when using this equipment.  
Do not use this equipment if you are under the influence of alcohol or drugs.  
Always use proper form and technique when using this equipment.  
Do not use this equipment if you are under the influence of alcohol or drugs.

# A TRULY GLOBAL COMPANY



## **AUSTRALIA / NEW ZEALAND**

Johnson Health Tech Australia Pty. Ltd.

## **BRAZIL**

Johnson Health Tech Brasil

## **CANADA**

Johnson Health Tech Canada

## **CHINA**

Johnson Health Tech (Shanghai) Co., Ltd.

## **CZECH REPUBLIC / SLOVAKIA**

Johnson Health Tech CZ & SK a.s.

## **DENMARK**

Johnson Health Tech Denmark ApS

## **FRANCE**

Johnson Health Tech France

## **GERMANY / AUSTRIA**

Johnson Health Tech GmbH

## **GREECE / BULGARIA / CYPRUS**

Johnson Health Tech Hellas SA

## **HONG KONG**

Johnson Health Tech Hong Kong

## **ITALY**

Johnson Health Tech Italia Spa

## **JAPAN**

Johnson Health Tech Japan

## **KOREA**

Johnson Health Tech Co., Ltd. Korea

## **MALAYSIA**

Johnson Fitness (Malaysia) SDN. BHD.

## **MEXICO**

Johnson Health Tech Mexico

## **NETHERLANDS / BELGIUM / LUXEMBOURG**

Matrix Fitness Benelux

## **PHILIPPINES**

Johnson Health Tech Philippines Inc.

## **POLAND**

Johnson Health Tech Sp. Z. O. O.

## **ROMANIA**

Johnson Health Tech Romania

## **RUSSIA**

Johnson Health Tech Russia

## **SOUTH AFRICA**

Johnson Health Tech South Africa (PTY) Ltd.

## **SPAIN / PORTUGAL**

Johnson Health Tech Ibérica SL

## **SWITZERLAND**

Johnson Health Tech (Schweiz) GmbH

## **TAIWAN**

Johnson Health Tech Taiwan

## **THAILAND / CAMBODIA / LAOS / MYANMAR**

Johnson Health Tech  
(Thailand) Co., Ltd.

## **TURKEY**

Johnson Health Tech Turkey

## **UNITED ARAB EMIRATES / SAUDI ARABIA / KUWAIT / QATAR / OMAN / JORDAN**

Johnson Health Tech Middle East

## **UNITED KINGDOM**

Johnson Health Tech UK Ltd.

## **UNITED STATES**

Johnson Health Tech North America

## **VIETNAM**

Johnson Health Tech (Vietnam) Co. Ltd.

Visit [matrixfitness.com](https://matrixfitness.com) for full contact information.

# MATRIX

## ABOUT MATRIX FITNESS

In 2001, Johnson Health Tech established Matrix Fitness to bring premium fitness equipment to the marketplace. Since then, we've become the fastest-growing commercial fitness equipment brand in the world. Matrix has leveraged continuous innovation and cross-cultural collaboration to emerge as an industry vanguard, constantly challenging standards and raising expectations for fitness equipment design and exercise technology.

Our product portfolio has expanded to over 500 products including strength equipment, cardio platforms, group exercise modalities, athletic performance training tools, fitness technology, integrated HIIT workouts, turnkey programming and much more. With over 30 subsidiaries around the world, Matrix is uniquely equipped to meet fitness and wellness needs in every corner of the globe.

Today, Matrix Fitness is dedicated to serving fitness facilities of all kinds, setting them apart in ways that attract and retain more members. Our mission is to delight and excite our customers through complete solutions and committed partnership provided by a world-class organization.



A close-up, low-angle shot of a Matrix Fitness gym machine, likely a leg press or similar strength training equipment. The machine is dark-colored with prominent silver or chrome cylindrical components. In the background, a rack of weights is visible, with a 45 lb weight plate in the foreground on the left. The lighting is dramatic, highlighting the metallic textures and creating deep shadows.

**MATRIX**  
Strong • Smart • Beautiful

**Matrix Fitness**

1600 Landmark Drive  
Cottage Grove, WI 53527 USA

**matrixfitness.com**

©2025 Matrix Fitness. All Rights Reserved.

AUTHORIZED MATRIX FITNESS DISTRIBUTOR